



Dromex

**WORKWEAR &
PERSONAL PROTECTIVE
EQUIPMENT**

**FOR THOSE WHO WORK BEYOND
THE ORDINARY**



PPE & WORKWEAR FOR SAFETY ANYWHERE.

Dromex is Africa's leading PPE & Workwear wholesaler dedicated to supplying quality protective products and workwear to employers and workers throughout industries around the world.

Originally founded as Industrial & Marine Sealing Systems (IMSS) in 1998 by our CEO, Stel Stylianou and operating from a 750m² warehouse, the Dromex range was strategically developed and has grown into one of South Africa's most trusted PPE brands.

Our new warehouse located in Cornubia Logistics Park now spans over ten's of thousands of square metres and features the latest technology storage, receiving & dispatch facilities to ensure that we have large volumes of internationally accredited PPE & Workwear in stock at all times and promptly dispatch in both quality & quantity.

As active members of various SABS technical committees, a member of SAPEMA and SAIOSH you can be assured that our PPE & Workwear comply with local industry standards and regulations.

Our PPE Specialists are continually up to date with the latest EN, ANSI, NFPA and additional international standards and are equipped to advise you on PPE & Workwear that is fit-for-purpose to keep the men & women who rely on protective equipment and clothing as comfortable & safe as possible.

QUALITY STANDARDS

We carefully select our suppliers, which ensures that we import products certified to international standards from ISO accredited companies around the world.

SERVICE

Our service and fiercely competitive pricing strategies result in often unparalleled levels of value for money and drive our quality PPE products through a loyal group of large and medium distributors throughout South Africa and Africa.

ADVICE & TRAINING

With extensive experience in various fields requiring PPE, we're able to provide on-site PPE evaluations, advice and training. Technical back up and distributor training is available at Dromex support centres in Durban, Johannesburg, Port Elizabeth, Cape Town & Richards Bay.

INNOVATION

New Products and innovations are continually being added to our range, and quality is reviewed on an on-going basis ensuring we offer the best possible specialist services to meet the ever changing demands of the PPE market.

We believe that all employees in any work environment are entitled to maximum safety protection and that employers should not have to compromise on the quality of the PPE products they provide for their staff.

Dromex



E. sales@dromex.co.za | W. www.dromex.co.za

CONTENTS

MARCH 2024
EDITION

FEATURES & RESOURCES

Pg 16 Dromex Globale: New Era of Workwear

Pg 18 Workwear Sizing Chart

Pg 20 Know Arc Safety

Pg 47 Poseidon 220 Protect

Pg 92 & 100 Respiratory Selection Guides

Pg 121 New Glove Standards

Pg 5

Corporate Range



Pg 19



Pg 46

Pg 53

Workwear

Pg 89

Head & Face Protection

Pg 92

Respiratory Protection

Pg 102

Hearing Protection

Pg 107

Safety Eyewear

Pg 114



Pg 120

Specialised Gloves

Pg 133

Working Gloves

Pg 140

Body Protection

Pg 158

Fall Arrest, Reflective
Wear & Support

Pg 167

Footwear



EVERY WEAR CORPORATE CLOTHING RANGE



The all new Dromex corporate clothing range will take you from the office to the golf course and is equally perfect for administrative, promotional, warehouse and delivery personnel.

We've ensured quality in every detail - every cotton thread, every button, every metre of fabric has been meticulously chosen with the user in mind to provide comfort & value.

Manufactured with the latest technology in pattern making, cutting & sewing automation, we are able to provide consistency in our clothing fit & durability.



We're committed to supplying quality without compromise and this promise is at the forefront of every Dromex garment.



Dromex

NEW



Dromex



LADIES STRETCH DENIMS

CODE: DWL-DENIMJEAN

- 75% Cotton, 23% Polyester, 2% Spandex, 10.5oz indigo blue denim
- Mid-rise waistline, modern cut & contoured fit
- Double needle stitching on inlegs, pockets, zip, back yoke & back rise
- Two front pockets, money pocket & two back pockets
- The natural fibres make this garment comfortable & breathable
- Suitable for casual & smart/casual use

Sizes: 28 - 50



Dromex



GOLF SHIRTS

CODE: DW-GOLFER

- 100% Polyester, 165gsm fabric
- Pique knit
- Lightweight
- Breathable
- Durable & retains colour
- High tear resistance
- Suitably paired with Dromex Chinos & Denims
- Available in six colours

Sizes: XS - 5XL

Available colours:



White



Grey



Red



Royal Blue



Navy



Black



Dromex

T-SHIRTS

CODE: DW-TSHIRT

- 100% Combed Cotton, 165gsm fabric (Grey melange: 88% Cotton/12% Polyester)
- Premium round neck t-shirt
- The natural fibres make this garment comfortable & breathable
- Suitable for use with Dromex Denims & Dromex Conti Suits
- Available in eight colours

Sizes: S - 3XL

DENIM JEANS

CODE: DW-DENIMJEAN

- 100% Cotton, 12oz indigo blue denim
- YKK Brass zip, Dromex closure button & rivet studs on all corners of front pockets
- Double needle topstitched inleg, back yoke & back rise
- Two front pockets, money pocket & two back pockets
- All pockets have double needle topstitching
- The natural fibres make this garment comfortable & breathable
- Suitable for casual & smart/casual use

Sizes: 28 - 50

Available t-shirt colours:



White

Grey

Yellow

Green

Red

Royal Blue

Navy

Black



Dromex

NEW

HORIZON **WORK SHIRTS**

**CODE: DW-KHAKI-SH /
DW-DSHIRT (DENIM)**

- 100% Cotton, 135gsm fabric (Denim 6.5oz)
- Short sleeved, relaxed fit button down shirt with button down collar
- Mitred box pleat chest pockets with mitred flap and hook & loop closure
- Posted & triple needle stitched seams
- Curved hem
- Lightweight & breathable
- Suitable for use with Dromex Cargo shorts

Sizes: S - 5XL

Available colours:



Olive/Khaki



Navy/Khaki



Stone



Denim

NEW



Dromex

STRETCH CARGO SHORTS

CODE: DW-ST-CARGO-SH

- 98% Cotton, 2% Elastane - 220/230gsm
- Side swing pockets with a right side coin pocket, 2 back pockets & 2 mitred cargo pockets with hook & loop closure
- Oxford reinforced cargo pockets and rear back pockets for added durability
- Posted side seams & inleg with triple needle stitching
- Comfortable, strong & flexible
- Perfect for everyday use with Dromex Golf Shirts, T-Shirts & Work Shirts
- **Sizes:** 28 - 50

Available colours:



Stone



Navy



Black



Dromex



FORMAL SHIRTS

CODE: DW-FORMS

- 100% Cotton Poplin, 135gsm fabric
- Available in long-sleeve & short-sleeve
- Relaxed fit button down shirt with button down collar
- V-shaped chest pocket
- Curved hem
- Lightweight & breathable
- Suitable for use with Dromex Denim & Chinos

Sizes: S - 3XL

Available colours:



White



Stone



Sky Blue



Navy



Black



Dromex



STRETCH CHINOS

CODE: DW-CHINOS

- 98% Cotton, 2% Elastane - 220/230gsm
- Side swing pockets with a right side coin pocket
- Comfortable, lightweight & breathable
- Suitable with Dromex Formal Shirts & Golf Shirts
- Durable and perfect for everyday use

Sizes: 28 - 50

Available colours:



Stone

Navy

Black



LEATHER BELT

CODE: DW-BELT

- Premium grain Buffalo leather belt
- Zinc alloy buckle
- Suitably worn with all Dromex chinos & denims

Sizes: S - 3XL



NEW



Dromex

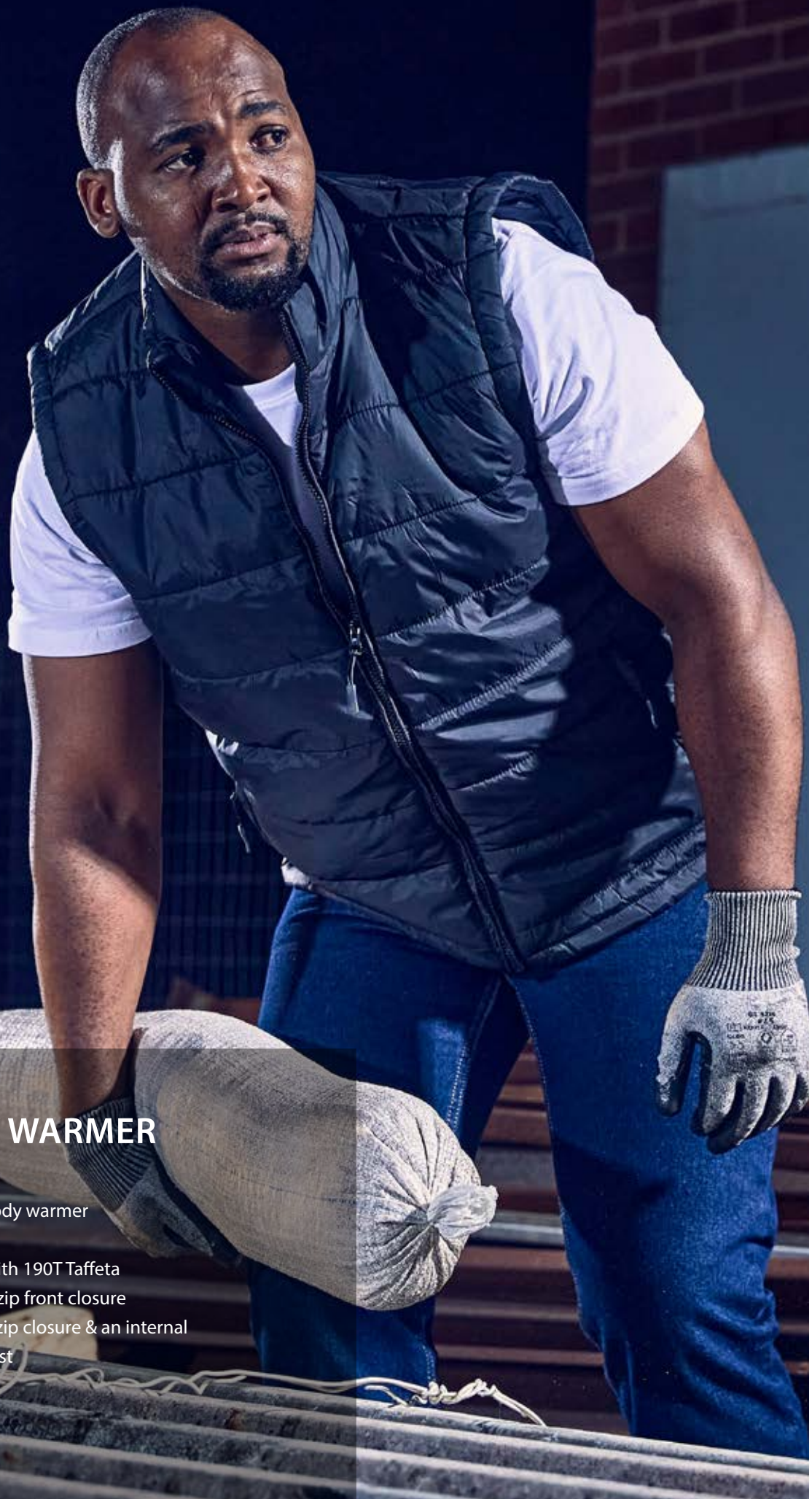

ACTIVE BODY WARMER

CODE: DB-STBW-A

- Unisex, black thermal body warmer
- Outer: 40D Nylon fabric
- Inner: 220gsm Cotton with 190T Taffeta
- Lightweight with metal zip front closure
- Two waist pockets with zip closure & an internal pocket on the right breast

Sizes: S - 3XL



Dromex

HARDBODY BODYWARMER

CODE: DB-STBW-H

- Unisex, navy, padded, thermal body warmer
- Outer: 65% Polyester/35% Cotton
- Inner: 100% Polyester with 190T Taffeta
- Lightweight with concealed front zip & storm flap button closure
- Four external pockets with storm flaps & an internal pocket on the left breast

Sizes: S - 3XL



Dromex



SOFTSHELL JACKET

CODE: DB-SS

- Stylish, lightweight, thermal & water resistant jacket with a micro polar fleece lining
- High collar with reverse zip closure & adjustable cuffs
- Outer: 125g laminated, 95% Polyester, 5% Elastane
- Inner: 100% Polyester Micro Polar Fleece 190g

Sizes: XS - 5XL

NEW



Dromex



PUFFER JACKETS

CODE: DB-PJ

- 400T Nylon outer & 260gsm synthetic down inner
- Insulating, water resistant & quick drying
- High-stand collar, elasticated waist and sleeve cuffs
- Chunky nylon zip closure with rubberized fastener
- 2 waist pockets & 2 inner jacket pockets
- Suitable for casual & smart/casual use

Sizes: S - XXL

Available colours:



Royal Blue



Black



Black/Charcoal



Black/Olive





FOR THOSE WHO WORK BEYOND THE ORDINARY

We know what it's like to face the deafening silence of 100 000 volts. How it feels to be one step away from danger every day. That is why Dromex believes that all employees are entitled to maximum protection without compromise.

From essential PPE to our state-of-the-art ARC protection, it is our responsibility to supply products that will deliver on this promise. And it's not something we take lightly.





NEWS

DROMEX GLOBALE: THE NEW ERA OF WORKWEAR

At Dromex we're committed to providing customers with only the best PPE and Workwear, and this means we're always looking at new ways of improving our range.

To achieve our goal of being Africa's premier PPE supplier, we've built our own 8000m² state-of-the-art manufacturing facility at the new intermodal Keystone Park hub in Hammarsdale to ensure we deliver on that promise.

Dromex Globale is an SABS approved facility, dedicated to manufacturing all Dromex workwear at competitive prices with uncompromising quality, conforming to the highest standards.

Our workwear factory is BBBEE Certified and successfully provided 500 jobs at commencement with an additional 600 jobs within the following 18-36 months.

The in-house training facility endeavours to upskill the youth of Hammarsdale resulting in an empowered workforce.

Designed with the stringent needs of local and international markets in mind, Dromex Globale will change the way we supply workwear.

THE FUTURE OF PPE BEGINS TODAY

Dromex believes that all employees are entitled to maximum protection and that employers should never have to compromise on the quality of the personal protective products they supply their staff.

And with our new Dromex Globale manufacturing facility, you can be sure you're dealing with a company that puts safety first.

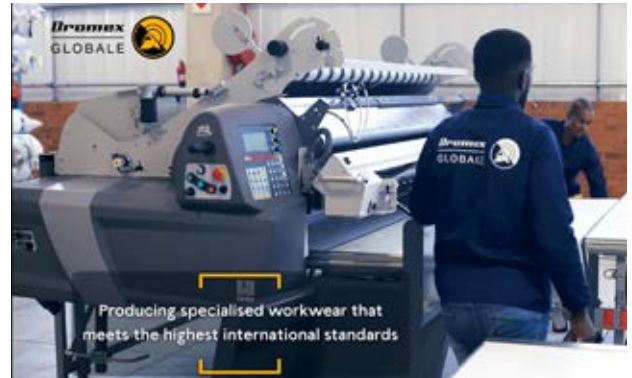



WORKWEAR STANDARDS

SABS is a statutory body that was established in terms of the Standards Act. These standards, **SANS** (South African National Standards) promote quality in connection with commodities, products and services. SABS mark bearing products are made under a permit from the SABS for specific products made to SANS standards by a registered manufacturer and include quality audits and verification.

SANS 434: This standard specifies requirements for the material, cut, make and trim of boilersuits, two-piece workwear suits, bib and brace overalls and coats and jackets (unlined) but does not cover garments designed for the protection against specific hazards. This covers the materials, workmanship, styles, sizes, makeup of the suits, stitches & seams.

SANS 1387: South African National Standard woven cotton and similar apparel fabrics. This covers 11 types of fabric, however the parts 1 to 4 are relevant to the workwear.

Part 4 is for cotton jean and drill fabrics.

J54 - Jean material with a 2/1 twill weave, 220g/m² minimum.

D59 - Drill material with a 4/1 satin weave, 270/m² minimum.

SANS 1423: Part 1 is for performance requirements for textile fabrics of low flammability. The standard covers the flammability performance requirements for four classes of washable apparel fabric, each class being divided into three flammability performance categories. NOTE The use of certain fabric combinations, trims, accessories and sewing threads that are not compatible can have an adverse effect on the flammability performance of a garment.

Fabric Class:

Class A: Capable of withstanding the required industrial or hospital laundry processes given in SANS 10146

Class B: Capable of withstanding wash treatments at temperatures of up to 95 °C

Class C: Capable of withstanding wash treatments at temperatures of up to 60 °C

Class D: Capable of withstanding wash treatments at temperatures of up to 40 °C

Flammability Category:

Category 1: The fabric does not ignite within a given time period.

Category 2: The fabric ignites within a given time period but the flame spread ceases within a specified distance.

Category 3: The fabric ignites within a given time period and might continue to flame but at a rate of flame propagation that is within a specified limit.

SANS 724: Personal Protective Equipment & Protective Clothing against thermal hazards of an electric Arc.

Design, selection and performance requirements of electric arc resistant clothing and equipment for the protection of persons against the thermal hazards of an electric arc, which could occur during operating or working on or near electrical equipment in the workplace.

SANS 61482 Live working, Protective clothing, against the thermal hazards of an electric arc. Part 1 is IEC 61482-1-1 determination of the arc rating (ATPV or EBT50) of flame resistant materials for clothing. IEC 61482-1-1 Method A is identical to ASTM F1959, with the exception of different laundry preconditioning requirements.

SANS 50471 EN 471 High-visibility warning clothing for professional use - test methods and requirements.

NFPA: The NFPA (National Fire Protection Association) is a United States trade association, albeit with some international members, that creates and maintains private, copyrighted standards and codes for usage and adoption by local governments.

NFPA 1975 Provisions apply to design, performance, testing and certification of non-primary protective work apparel and the individual garments comprising work apparel.

Specifies criteria for thermally stable textiles that will not rapidly deteriorate, melt, shrink, or adhere to the wearer's skin, and also provides optional requirements and tests to verify flame resistance, odour resistance, water resistance and insect repellancy.

NFPA 70E Safe work practices to protect personnel by reducing exposure to major electrical hazards. NFPA 70E helps companies and employees avoid workplace injuries and fatalities due to shock, electrocution, arc flash, and arc blast.

The Standard includes guidance for making hazard identification and risk assessments, selecting appropriate PPE, establishing an electrically safe work condition and employee training.

NFPA 2112 This standard protects workers from flash fire exposure and injury by specifying performance requirements and test methods for flame-resistant fabric and garments. Criteria cover design, construction, evaluation and certification of flame-resistant garments for use by industrial personnel, with the intent of not contributing to the burn injury of the wearer, providing a degree of protection to the wearer and reducing the severity of burn injuries resulting from short-duration thermal exposures resulting from accidental exposure to flash fires.

ISO (the International Organization for Standardization) is a worldwide federation of national standards bodies, ISO member bodies. International Standards are carried out through ISO technical committees and each member of the body has the right to be represented.

ISO 13688 This International Standard specifies general performance requirements for ergonomics, innocuousness, size designation, ageing, compatibility and marking of protective clothing and the information to be supplied by the manufacturer with the protective clothing. This International Standard is only intended to be used in combination with other standards containing requirements for specific protective performance and not on a stand-alone basis.

ISO 6530 This International Standard specifies a test method for the measurement of indices of penetration, absorption and repellence for protective clothing materials against liquid chemicals, mainly chemicals of low volatility. Two levels of the potential performance of materials are assessed by this method of testing to meet with possible requirements for protection against:

a) deposition on the surface of a material, at minimal pressure, of spray droplets up to coalescence or occasional small drips;

b) contamination by a single low-volume splash or low-pressure jet, allowing sufficient time to divest the clothing or take other action as necessary to eliminate any hazard to the wearer from chemical retained by the protective garment, or, in circumstances where pressure is applied to liquid contaminants on the surface of the clothing material, as a result of natural movements of the wearer (flexing of contaminated areas of clothing at arms, knees, shoulders) and contact with contaminated surfaces (e.g. walking through sprayed foliage). The tested chemicals for the South African market are: HNO₃ (Nitric Acid), HCl (Hydrochloric Acid), H₂SO₄ (Sulphuric Acid) and NaOH (Sodium Hydroxide).



DROMEX WORKWEAR SIZING CHART

XS	S	M	L	XL	2XL	3XL	4XL	5XL	6XL
----	---	---	---	----	-----	-----	-----	-----	-----

SABS SANS 434

30/77	32/82	34/87	36/92	38/97	40/102	42/107	44/112	46/117	48/122	50/127	52/132	54/137	56/142	58/147	60/152	62/157	64/162	66/167
94	99	104	109	114	119	124	129	134	139	144	149	154	159	164	169	174	179	184
cm	47	47	48	48	49	49	50	51	51	52	52	53	53	54	54	54	54	54

WAIST EXTENDED

26/67	28/72	30/77	32/82	34/87	36/92	38/97	40/102	42/107	44/112	46/117	48/122	50/127	52/132	54/137	56/142	58/147	60/152	62/157
80	85	90	95	100	105	110	115	120	125	130	135	140	145	150	155	160	165	170
cm	102	104	106	108	110	110	111	111	111	111	111	112	112	113	113	113	114	114

OUTSIDE LEG

78	79	80	81	82	82	82	82	81	81	80	80	80	80	80	80	80	80	80
cm																		

INLEG

80	80	80	80	80	80	80	80	80	80	80	80	80	80	80	80	80	80	80
cm																		

EXECUTIVE FIT

30/77	32/82	34/87	36/92	38/97	40/102	42/107	44/112	46/117	48/122	50/127	52/132	54/137	56/142	58/147	60/152	62/157	64/162
95	100	105	110	115	120	125	130	135	140	145	150	155	160	165	170	175	180
cm	68	68	69	70	71	72	73	74	74	75	76	76	76	77	77	78	78

CHEST SIZE

49	49	50	50	51	51	52	52	53	53	54	54	55	55	56	56	57	57
cm																	

BACK LENGTH

36	38	40	42	44	46	48	50	52	54	56	58	60	62	64	66	68	70
cm																	

SLEEVE LENGTH

75	80	85	90	95	100	105	110	115	120	125	130	135	140	145	150	155	160
cm	94	96	98	100	102	103	103	103	103	103	103	104	104	105	106	106	106

BACKWIDTH

70	71	71	72	73	74	74	74	73	73	72	72	72	72	72	72	72	72
cm																	

WAIST EXTENDED

26/67	28/72	30/77	32/82	34/87	36/92	38/97	40/102	42/107	44/112	46/117	48/122	50/127	52/132	54/137	56/142	58/147	60/152
75	80	85	90	95	100	105	110	115	120	125	130	135	140	145	150	155	160
cm	94	96	98	100	102	103	103	103	103	103	103	104	104	105	106	106	106

OUTSIDE LEG

70	71	71	72	73	74	74	74	73	73	72	72	72	72	72	72	72	72
cm																	

INLEG

64	64.5	65	65.5	66	68.5	69	70.5	72	73.5	75	76.5	77	77.5	78	78.5	79	79.5
cm	43	43	43	44	45	45	45	46	47	48	49	49	49	50	50	50	50

COMFIT

30/77	32/82	34/87	36/92	38/97	40/102	42/107	44/112	46/117	48/122	50/127	52/132	54/137	56/142	58/147	60/152	62/157	64/162
92	97	102	107	112	117	122	127	132	137	142	147	152	157	162	167	172	177
cm	64	64.5	65	65.5	66	68.5	69	70.5	72	73.5	75	76.5	77	77.5	78	78.5	79

CHEST SIZE

43	43	43	44	45	45	45	45	46	47	48	49	49	49	50	50	50	50
cm																	

BACK LENGTH

41	42.5	45.05	45.5	47	48.5	50	51.5	53	55	56	57.5	59	60.5	62	63.5	65	66.5
cm																	

SLEEVE LENGTH

26/67	28/72	30/77	32/82	34/87	36/92	38/97	40/102	42/107	44/112	46/117	48/122	50/127	52/132	54/137	56/142	58/147	60/152
72	77	82	87	92	97	102	107	112	117	122	127	132	137	142	147	152	157
cm	96.5	97.5	98.5	100	101	102.5	103.5	105	106	107.5	108.5	110	111	112.5	113.5	114.5	115.5

WAIST EXTENDED

71.5	72	72.5	73	73.5	74.5	75	75.5	76.5	77	77.5	78.5	79	80	80.5	81	81.5	82
cm																	

OUTSIDE LEG

71.5	72	72.5	73	73.5	74.5	75	75.5	76.5	77	77.5	78.5	79	80	80.5	81	81.5	82
cm																	

INLEG

FABRIC COLOUR KEY





Dromex

ARC

ATPV 100 cal/cm²



ATPV 100 cal/cm²



INTRODUCING THE DROMEX ARC RANGE

Through years of consulting with experts, testing fabric combinations and working with world-leading testing facilities, we are proud to bring the Dromex ARC range of workwear and PPE to the global stage.

Dromex is committed to developing quality products, that effectively mitigate risk, which extends to our specialist offering - specifically our ARC range which has been designed to reduce the risks associated with hazardous industries, where 2nd & 3rd degree burns can occur.

Our ARC workwear is manufactured locally using our custom Dromex A.P.T™ (Arc Protection Technologies) fabric and is certified to the highest local and international standards.

Each garment is rated to varying degrees for specific environments and conditions and our ARC range includes a number of styles and accessories for various industries.

Dromex ARC workwear and PPE is suitable during any work with or within the vicinity of industrial electrical panels switch rooms, substations and utilities power generators.

THE SAFETY IS IN THE DETAIL

When it comes to safety, the smallest detail can make a difference. Through extensive research, development, and testing, we've created an ARC range that's every bit as comfortable and practical as it is safe:

- Inherent flame-retardant thread
- Triple needle stitched seams
- Transfer print & embroidery logos
- Flame-retardant Velcro
- Double needle stitched FR reflective tape



MEETING THE HIGHEST STANDARDS

Dromex believes in uncompromising safety, so we've insisted that the integrity of our specialist ARC range also passes the most stringent garment tests in addition to the fabric tests.

We're proud to be associated with the leading standards authorities locally and internationally enabling us to produce certified ARC workwear.

These standards include:

- IEC 61482-1-1 · IEC 61482-1-2 · NFPA 70E · NFPA 2112
- SANS 724 · ASTM F1959 · ASTM F2621-12
- EN 11611:2015 · EN 11612:2015 · EN 61482-1-2:2014



EN

At Dromex we believe that all employees are entitled to maximum safety protection and that employers should never have to compromise on the quality of protective equipment they supply their staff.

Our Arc range ensures that we deliver on that promise.





UNDERSTANDING ARC WORKWEAR

FR COTTON vs INHERENT FABRICS

> FLAME RETARDANT COTTON FABRICS:

FR Cotton fabrics have had flame retardants engineered into the fabric to create flame resistance thereby producing fabrics that have guaranteed flame retardancy for the life of the garment.

> INHERENT FLAME RETARDANT FABRICS:

'Inherent fabrics' consist of synthetic fibre that do not require additional FR chemical treatments - each fibre is 'inherently' flame retardant.

All FR fabrics (inherent & treated) are engineered to prevent ignition. While the fabrics are essentially different, technological advancements and development means that the efficacy of both fabrics are very similar and choosing Arc workwear should be based on:

- Arc hazard & environment of use
- Performance & certifications
- Comfort & quality
- Durability
- Value & availability
- Brand reputation

Did You Know?

Dromex A.P.T™ FR Cotton Fabric has passed "Red Metal" testing which offers additional bodily protection from molten metal, vaporised copper & metal oxides up to 1400°C. This offers the wearer effective protection and peace of mind.

Molten metal is a deadly hazard that can easily penetrate synthetic lightweight fabrics during an Arc Flash incident.



ArcWear
3018 Eastpoint Parkway
Louisville, Kentucky 40223

Page 1 of 1

Date: 12/12/2019 Test Report: 1911P05-X
Client: Dromex
1 Blasé Road, New Germany
Durban, KZN
South Africa 3620
Sample(s) Received: 10/14/2019
Sample Description (provided by client): Dromex, Style Dromex A.P.T., 9.0 oz/yd² 305 g/m² Woven, 88% FR Cotton 12% Nylon, Navy, AAD 9.7 oz/yd² 329 g/m², ArcWear# 1911P05
Testing Date: 12/6/2019
Procedure: Testing was completed in accordance with the method identified below at ArcWear in Louisville, Kentucky.

FLAMMABILITY TESTING

When a garment is tested for flammability against the NFPA 2112 standard it has already been washed 100 times before NFPA 2112 tests are applied.

At Dromex we believed in the superior quality of our fabric and took this test one step further.

Our Dromex A.P.T™ fabric was tested against the NFPA 2112 standard and passed after 200 washes.

ARC WORKWEAR LIFESPAN

The lifespan of an Arc garment is dependent on many factors such as wash care, storage between use and wear and tear during use.

E.g. If the garment has been in use for 3 weeks and a worker is exposed to an Arc Flash incident the workwear and PPE needs to be replaced therefore the lifespan of the garment has ended. Likewise if Arc workwear & PPE is damaged during use, it needs to be removed from service and replaced immediately.

Dromex A.P.T 200 Wash Certificate

ASTM D3776/D3776M						
Standard Test Method for Mass per Unit Area Fabric Weight-Option C Small Swatch						
Preconditioning:	200 cycles of washing and drying as specified in sec 8.1.3 of NFPA 2112-18					
Conditioning:	ASTM D1776					
Sieve(s) Included:	No					
Fabric Mass (oz/yd²):	10.18					
Fabric Mass (g/m²):	345					
ASTM D6413/D6413M-15						
Standard Test Method for Flame Resistance of Textiles (Vertical Test)						
Preconditioning:	200 cycles of washing and drying as specified in sec 8.1.3 of NFPA 2112-18					
	Length Direction					AVG Length
	1	2	3	4	5	
Afterflame Time (sec)	0.2	0.2	0.0	0.0	0.0	0.1
Afterglow Time (sec)	1.0	1.0	1.2	1.2	1.0	1.1
Char Length (mm)	78	78	72	75	81	77
Melting?	No	No	No	No	No	
Dripping?	No	No	No	No	No	
	Width Direction					AVG Width
	1	2	3	4	5	
Afterflame Time (sec)	0.2	0.2	0.0	0.0	0.0	0.1
Afterglow Time (sec)	1.2	1.4	1.0	1.0	1.4	1.2
Char Length (mm)	61	75	78	72	78	73
Melting?	No	No	No	No	No	
Dripping?	No	No	No	No	No	

Signed for the Company by:
Jill Kirby
Lab Manager
ArcWear
Digitally signed by Jill Kirby
Date: 2019.12.12 09:22:11 -0500
This test report shall not be reproduced except in full, without written approval of ArcWear. Test results relate only to the item submitted for testing.
Neither High Hoagland Consulting, Inc. dba ArcWear, nor its affiliates, nor any person acting on behalf of any of them:
a) makes any warranty, express or implied, with respect to the use of any information, apparatus, method, or process disclosed in this report or that such use may not infringe privately owned rights; or
b) assumes any liabilities with respect to the use of, or for damages resulting from the use of, any information, apparatus, method, or process disclosed in this report
Warranty Disclaimer and Limitation of Liability. The Services and Test Reports provided by ARCWEAR hereunder shall materially conform with the written product and service specifications, descriptions and documentation delivered by ARCWEAR. ALL SERVICES ARE DELIVERED WITHOUT WARRANTY OF ANY KIND EXPRESS OR IMPLIED, INCLUDING, WITHOUT LIMITATION, ANY WARRANTY OF TITLE, MERCHANTABILITY, OR FITNESS FOR A PARTICULAR PURPOSE. CUSTOMER'S SOLE REMEDY FOR ARCWEAR'S BREACH OF ALL WARRANTIES HEREUNDER OR ANY TERM OR CONDITION OF THIS AGREEMENT, IS AS SET FORTH IN THIS PARAGRAPH. IN NO EVENT SHALL ARCWEAR BE LIABLE TO CUSTOMER OR THIRD PARTIES UNDER THIS AGREEMENT FOR ANY AMOUNT IN EXCESS OF THE FEES ACTUALLY PAID BY CUSTOMER TO ARCWEAR FOR SERVICES PROVIDED HEREUNDER DURING THE SIX (6) MONTH PERIOD PRIOR TO THE ARISING OF SUCH CLAIMS. ARCWEAR SHALL NOT BE LIABLE FOR ANY INDIRECT, INCIDENTAL, SPECIAL, CONSEQUENTIAL, PUNITIVE, OR EXEMPLARY DAMAGES INCLUDING, BUT NOT LIMITED TO, DAMAGES FOR PERSONAL INJURY, BODILY INJURY, PROPERTY, LOST PROFITS, GOOD WILL, USE, DATA, OR OTHER INTANGIBLE LOSSES WHETHER DERIVED FROM THIRD PARTY CLAIMS OR LOSSES OF ANY NATURE WHATSOEVER OR OTHERWISE, REGARDLESS OF WHETHER ARCWEAR WAS ADVISED OF THE POSSIBILITY OR LIKELIHOOD OF SUCH DAMAGES OR COSTS OCCURRING, AND WHETHER SUCH LIABILITY WAS BASED UPON TORT, WARRANTY, NEGLIGENCE, STRICT LIABILITY, CONTRACT, PRODUCT LIABILITY, OR ANY OTHER CLAIM AT LAW OR IN EQUITY. THE LIMITATIONS OF LIABILITY SET FORTH HEREIN SHALL BE APPLICABLE TO AND SHALL INURE TO THE BENEFIT OF ARCWEAR AND ITS OFFICERS, DIRECTORS, EMPLOYEES, AGENTS, ATTORNEYS, AFFILIATES, AND PARTNERS. TO THE EXTENT PERMITTED BY APPLICABLE LAW, CUSTOMER IRREVOCABLY WAIVES ANY STATE, FEDERAL, OR LOCAL LAW, REGULATION, OR STATUTE THAT WOULD OTHERWISE LIMIT OR PROHIBIT LIMITATIONS OF OR GENERAL RELEASES OF LIABILITY. THE LIMITATIONS SET FORTH HEREIN ARE INTENDED TO CONFORM TO THE FULLEST EXTENT POSSIBLE WITH ANY APPLICABLE LAW, REGULATION, OR STATUTE PROHIBITING OR LIMITING THE EXCLUSION OR LIMITATION OF DAMAGES OR THE DISCLAIMER OF WARRANTIES AND REPRESENTATIONS.



ARC THERMAL PROTECTION VALUE

ATPV is the embroidered or printed markings on all Arc workwear & PPE.

ATPV is measured in cal/cm² and is defined as the maximum incident heat energy that a fabric can absorb and lessen the injury against a 2nd or 3rd degree burn.

For example, if a worker has the potential to be exposed to an incident where the heat energy level is less than 4.0 cal/cm², the required ATPV clothing & PPE is a minimum of 4 cal/cm².







HEAT ATTENUATION FACTOR (HAF)

HAF refers to the amount of heat blocked by the FR fabric. Though a fabric may be flame resistant, it may not block all of the heat to which it is exposed. An HAF of 85% means that it will block 85% of the heat the fabric encounters. This applies to a short burst of heat - usually less than one second. In the event of prolonged heat exposure, the HAF would be lower.

Note: Synthetic fabrics generally have a lower HAF than Cotton FR Fabrics.



ARC WORKWEAR & PPE SELECTION

HAZARD / RISK CATEGORY	CLOTHING DESCRIPTION RECOMMENDED	MINIMUM REQUIRED ARC RATING OF PPE CAL/CM ²
	Arc Rated FR shirt & FR pants or coverall	4
	Arc Rated FR shirt & FR pants or coverall	8
	Arc rated FR shirt or FR pants or FR coverall and arc flash suit selected so that the system arc rating meets the required minimum	25
	Arc rated FR shirt or FR pants or FR coverall and arc flash suit selected so that the system arc rating meets the required minimum	40

NOTE: Energy / Incident Analysis & Calculation assessments are available on request to ensure correct Arc Workwear & PPE selection according to the arc hazard present.



100CAL ARC SUIT BIB & BRACE, JACKET & HOOD



OEKO-TEX®

CODES: DW-ARC100-J / BP (JACKET / BIP PANTS)
DH-ARC100-SH (SWITCHING HOOD)
DG-ARC100 (SWITCHING GLOVE)
DH-ARC100-KIT (JACKET/PANTS/VENTILATED HOOD, GLOVES)

NFPA 2112, NFPA 70E, SANS 724, ASTM F2621-12, EN 11612:2015,
EN 61482-2-2:2020
HOOD: ASTM F2178-12
GLOVE: ASTM F2675

- ATPV 100cal/cm²
- Dromex A.P.T Fabric - 88% Cotton, 12% Nylon
- Triple layer construction: 14oz outer, 250gsm meta aramid FR mat lining & 14oz inner
- Inherent flame retardant thread throughout
- Fully triple needle stitched garment
- Concealed YKK Vizlon zip on jacket
- Flame retardant hook & loop closures
- Flame retardant knitted rib cuffing
- cal/cm² Rating embroidery on hood, jacket, bib & brace and gloves

Hood:

- Back flap with hook & loop closure for built-in fan/air system
- Flame retardant hook & loop closures
- Dromex BSD 100cal/cm² Arc Visor with *Real View Technology*
- Integrated fresh air arc flash ventilation system for cooling

Sizes:

- Jackets: S - 5XL
- Bib & Brace: S - 5XL
- Gloves: S/M & L/XL (*see pg 40 for more info*)

Suitable Use:

- Substations & switchrooms
- Utilities & power generators
- Industrial electrical maintenance & installations
- Mining, chemical & refineries



55CAL ARC SUIT BIB & BRACE, JACKET & HOOD

CODES: DW-ARC55-J / BP (JACKET / BIB PANTS)

DH-ARC55-SH (SWITCHING HOOD)

DH-ARC55-SHV (SWITCHING HOOD WITH VENTILATION)



EN



OEKO-TEX®

IEC 61482-1-1, NFPA 2112, NFPA 70E, SANS 724,

ASTM F1959, ASTM F2621-12, EN 11612:2015

HOOD: ASTM F2178-12

- ATPV 55cal/cm²
- Dromex A.P.T Fabric - 88% Cotton, 12% Nylon
- Double layer construction: 14oz & 9oz inner
- Inherent flame retardant thread throughout
- Fully triple needle stitched garment
- YKK Concealed brass zips on jackets
- Flame retardant hook & loop closures
- Flame retardant knitted rib cuffing
- cal/cm² Rating embroidery on hood, jacket, bib & brace

Hood:

- Back flap with hook & loop closure for built-in fan/air system
- Flame retardant hook & loop closures throughout
- Dromex BSD Arc Visor with *Real View Technology*
- Available with or without ventilation

Sizes:

- Jackets: S - 5XL
- Bib & Brace: S - 5XL

Suitable Use:

- Substations & switchrooms
- Utilities & power generators
- Industrial electrical maintenance & installations
- Mining, chemical & refineries





25CAL ARC SUIT

CODE: DW-ARC25-J / P



OEKO-TEX®

IEC 61482-1-1, NFPA 2112, NFPA 70E, SANS 724,
ASTM F1959, ASTM F2621-12, ASTM 1506-19,
EN 11612:2015

- ATPV 25cal/cm²
- 14oz Dromex A.P.T Fabric - 88% Cotton, 12% Nylon
- Flame retardant thread throughout
- YKK Concealed brass zips on jacket & pants
- Flame retardant hook & loop closures
- Fully triple needle topstitched garment
- Flame retardant knitted rib cuffing
- Three jacket pockets with mitred flap & flame retardant hook & loop closure & side swing pocket on pants
- cal/cm² Rating embroidery on jacket & pants

Sizes:

- Jackets: S - 5XL
- Pants: S - 5XL

Suitable Use:

- Substations & switchrooms
- Utilities & power generators
- Industrial electrical maintenance & installations
- Mining, chemical & refineries

NEW

Dromex
ARC



25CAL ARC BOILERSUIT

CODE: DW-ARC25-RT-0



OEKO-TEX®

IEC 61482-1-1, IEC 61482-1-2, NFPA 2112, NFPA 70E,
SANS 724, ASTM F1959, ASTM F2621-12, EN 11611:2015,
EN 11612:2015, EN 61482-1-2:2014, CE 0338:2016

- ATPV 25cal/cm²
- Dromex A.P.T Fabric - 88% Cotton 12% Nylon, 305gsm
- Flame retardant thread throughout
- YKK concealed brass zip
- Flame retardant hook & loop closures
- Triple needle topstitched garment
- Flame retardant knitted rib cuffing
- Two breast pockets with mitred flap & flame retardant hook & loop closure & side entry hip pockets
- 50mm Flame retardant reflective tape on arms, legs & "X" on back
- cal/cm² Rating embroidery on right breast pocket flap

Sizes: 30 - 62

Suitable Use:

- Substations & switchrooms
- Utilities & power generators
- Industrial electrical maintenance & installations
- Mining, chemical & refineries





15CAL ARC SUIT

CODE: DW-ARC15-J / P



OEKO-TEX®

IEC 61482-1-1, IEC 61482-1-2, NFPA 2112, NFPA 70E, SANS 724, ASTM F1959, ASTM F2621-12, EN 11611:2015, EN 11612:2015, EN 61482-1-2:2014, CE 0338:2016

- ATPV 15cal/cm²
- Dromex A.P.T Fabric - 88% Cotton 12% Nylon, 305gsm
- Flame retardant thread throughout
- YKK concealed brass zip on jacket & pants
- Flame retardant hook & loop closures
- Full triple needle topstitched garment
- Flame retardant knitted rib cuffing
- Three jacket pockets with mitred flap & flame retardant hook & loop closure & side swing pockets on pants
- 50mm Flame retardant reflective tape on arms & legs
- cal/cm² Rating embroidery on jacket & pants

Sizes:

- Jackets: 30 - 68
- Pants: 28 - 66

Suitable Use:

- Substations & switchrooms
- Utilities & power generators
- Industrial electrical maintenance & installations
- Mining, chemical & refineries



12.4CAL ARC SUIT*

CODE: DW-ARC12-OR



OEKO-TEX®

IEC 61482-1-1, IEC 61482-1-2, NFPA 2112, NFPA 70E,
SANS 724, ASTM F1959, ASTM F2621-12, EN 11611:2015,
EN 11612:2015, EN 61482-1-2:2014, CE 0338:2016

- ATPV 12.4 cal/cm² *Tested & approved up to 15 cal/cm²
- Dromex A.P.T Fabric - 88% Cotton 12% Nylon, 305gsm
- Flame retardant thread throughout
- YKK concealed brass zip on jacket & pants
- Flame retardant hook & loop closures
- Full triple needle topstitched garment
- Flame retardant knitted rib cuffing
- Three jacket pockets with mitred flap & flame retardant hook & loop closure & side swing pockets on pants
- 50mm Flame retardant reflective tape on arms & legs
- cal/cm² Rating embroidery on jacket & pants

Sizes:

- Jackets: 32 - 60
- Pants: 28 - 56

Suitable Use:

- Substations & switchrooms
- Utilities & power generators
- Industrial electrical maintenance & installations
- Mining, chemical & refineries





15CAL ARC BOILERSUIT

CODE: DW-ARC15-O



OEKO-TEX®

IEC 61482-1-1, IEC 61482-1-2, NFPA 2112, NFPA 70E, SANS 724, ASTM F1959, ASTM F2621-12, EN 11611:2015, EN 11612:2015, EN 61482-1-2:2014, CE 0338:2016

- ATPV 15 cal/cm²
- Dromex A.P.T Fabric - 88% Cotton 12% Nylon, 305gsm
- Flame retardant thread throughout
- YKK concealed brass zip
- Flame retardant hook & loop closures
- Triple needle topstitched garment
- Flame retardant knitted rib cuffing
- Two breast pockets with mitred flap & flame retardant hook & loop closure & side entry hip pockets
- 50mm Flame retardant reflective tape on arms, legs & "X" on back
- cal/cm² Rating embroidery on right breast pocket flap

Sizes: 30 - 64

Suitable Use:

- Substations & switchrooms
- Utilities & power generators
- Industrial electrical maintenance & installations
- Mining, chemical & refineries





LADIES 15CAL ARC SUIT

CODE: DWL-ARC15-J / P



OEKO-TEX®

IEC 61482-1-1, IEC 61482-1-2, NFPA 2112,
NFPA 70E, SANS 724, ASTM F1959, ASTM F2621-12,
EN 11611:2015, EN 11612:2015, EN 61482-1-2:2014

- ATPV 15cal/cm²
- Dromex A.P.T Fabric - 88% Cotton, 12% Nylon, 305gsm
- Full triple needle topstitched garment
- Flame retardant thread throughout
- YKK Concealed brass zips on jackets & pants
- Flame retardant hook & loop closures
- Flame retardant knitted rib cuffing
- Three jacket pockets with mitred flap & flame retardant hook & loop closure & side swing pockets on pants
- cal/cm² Rating embroidery on jacket & pants
- 50mm Flame retardant reflective tape on arms & legs

Sizes: S - 5XL

Suitable Use:

- Substations & switchrooms
- Utilities & power generators
- Industrial electrical maintenance & installations
- Mining, chemical & refineries





15CAL ARC SHIRT

CODE: DW-ARC15-S



OEKO-TEX®

IEC 61482-1-1, IEC 61482-1-2, NFPA 2112, NFPA 70E, ASTM F1959,
ASTM F2621-12, EN 11611:2015, EN 61482-1-1:2009
EN 11612:2015, EN 61482-2:2009, CE 0338:2016

- ATPV 15 cal/cm²
- Dromex A.P.T Fabric - 88% Cotton 12% Nylon, 305gsm
- Flame retardant thread throughout
- Flame retardant melamine buttons
- Triple needle topstitched garment
- Two mitred breast pockets with double needle topstitching & mitred flap
- 50mm Lime/silver/lime FR reflective tape
- cal/cm² Rating embroidery on right breast

Sizes: S - 5XL

Suitable Use:

- Substations & switchrooms
- Utilities & power generators
- Industrial electrical maintenance & installations
- Mining, chemical & refineries



9.6CAL ARC SHIRT

CODE: DW-ARC9,6



OEKO-TEX®

IEC 61482-1-2, NFPA 2112, NFPA 70E, ASTM F2621-12,
EN 11611:2015, EN 11612:2015

- ATPV 9.6 cal/cm²
- Dromex A.P.T Fabric - 88% Cotton 12% Nylon, 237gsm
- Flame retardant thread throughout
- Flame retardant melamine buttons
- Triple needle topstitched garment
- Two mitred breast pockets with double needle topstitching & mitred flap
- 50mm silver FR reflective tape
- cal/cm² Rating embroidery on right breast

Sizes: S - 5XL

Suitable Use:

- Substations & switchrooms
- Utilities & power generators
- Industrial electrical maintenance & installations
- Mining, chemical & refineries





40CAL ARC THERMAL JACKET

CODE: DW-ARC40-WJ



OEKO-TEX®

NFPA 2112, EN 11611:2015, EN 11612:2015

- ATPV 40 cal/cm²
- Dromex A.P.T Fabric - 88% Cotton 12% Nylon, 305gsm (Outer fabric & lining)
- Flame retardant wadding interlining
- Flame retardant thread throughout
- Flame retardant hook & loop closure on pockets & front
- Flame retardant rib knit cuffing on sleeves
- cal/cm² Rating embroidery on right breast
- 50mm Flame retardant reflective tape on arms
- Double needle topstitching on armholes & shoulders
- Rounded chest pocket and mitred flap with FR hook & loop closure
- Concealed YKK chunky nylon zip with 25mm FR hook & loop closure

Sizes: XS - 5XL

Suitable Use:

- Substations & switchrooms
- Utilities & power generators
- Industrial electrical maintenance & installations
- Mining, chemical & refineries



15CAL ARC X-BIB

CODE: DW-ARCBIB12.4



EN

OEKO-TEX®

IEC 61482-1-2, NFPA 2112, NFPA 70E, ASTM F1959,
EN 11611:2015, EN 11612:2015, EN 61482-1-2:2014,
EN ISO 20471:2013

- ATPV 15 cal/cm²
- Dromex A.P.T Fabric - 88% Cotton 12% Nylon, 305gsm
- Flame retardant thread throughout
- Adjustable flame retardant hook & loop closure
- 50mm Lime/silver/lime flame retardant reflective tape

Sizes: S - XL
2XL - 5XL

Suitable Use:

- Substations & switchrooms
- Utilities & power generators
- Industrial electrical maintenance & installations
- Mining, chemical & refineries





21CAL ARC DENIM JEANS

CODE: DW-ARC21-DJ



OEKO-TEX®

NFPA 2112, NFPA 70E, ASTM F1959, EN 11611:2015,
EN 11612:2015, EN 61482-1-2:2014

- ATPV 21cal/cm²
- 100% Cotton, 14oz Arc Denim
- Flame retardant corespun 40 thread
- YKK concealed brass zip
- Double needle top stitching at inleg & back rise
- Swing pockets with double needle topstitch
- Five belt loops
- Back yoke with double needle topstitching
- Two back pockets with double needle topstitching
- cal/cm² Rating embroidery on right back pocket

Sizes: 28 - 50

Suitable Use:

- Substations & switchrooms
- Utilities & power generators
- Industrial electrical maintenance & installations
- Mining, chemical & refineries



Dromex
ARC



15CAL ARC DUST COAT

CODE: DW-ARDC



OEKO-TEX®

NFPA 2112, NFPA 70E, ASTM F1959, ASTM F2621-12,
EN 11611:2015, EN 11612:2015, EN 61482-1-2:2014,
EN ISO 204471:2013, SANS 724

- ATPV 15cal/cm²
- Dromex A.P.T Fabric - 88% Cotton, 12% Nylon, 305gsm
- Flame retardant thread throughout
- Concealed flame retardant plastic snap buttons & 25mm x 85mm hook & loop closure at front
- Flame retardant rib cuff
- 50mm Lime/silver/lime flame retardant reflective tape on arms, chest and "X" on back
- Triple needle topstitched shoulders & armholes
- Slit at centre back hem
- cal/cm² Rating embroidery on right breast

Sizes: S - 5XL

Suitable Use:

- Substations & switchrooms
- Utilities & power generators
- Industrial electrical maintenance & installations
- Mining, chemical & refineries





9.9CAL T-SHIRT UNDERGARMENTS

CODE: DW-ARC9.9-LST (LONG SLEEVE)
DW-ARC9.9-SST (SHORT SLEEVE)



IEC 61482-1-2, NFPA 2112, NFPA 70E, ASTM F1959,
EN 11611:2015, EN 11612:2015, EN 61482-1-2:2014

- ATPV 9.9 cal/cm²
- 88% Cotton, 12% Nylon Interlock FR Knitted Fabric, 203gsm
- Flame retardant thread throughout
- Flame retardant knitted rib cuffing
- cal/cm² Rating embroidery on left breast
- Suitably worn under any Dromex Arc garment

Sizes: S - 5XL

Suitable Use:

- Substations & switchrooms
- Utilities & power generators
- Industrial electrical maintenance & installations
- Mining, chemical & refineries



9.9CAL BOXER SHORTS

CODE: DW-ARC 9.9-BSH



IEC 61482-1-2, NFPA 2112, NFPA 70E, ASTM F1959,
EN 11611:2015, EN 11612:2015, EN 61482-1-2:2014

- ATPV 9.9 cal/cm²
- 88% Cotton, 12% Nylon Interlock FR Knitted Fabric, 203gsm
- Flame retardant thread throughout
- Flame retardant knitted waist band
- cal/cm² Rating embroidery on left leg
- Suitably worn under any Dromex Arc garment

Sizes: S - M
L - XL

Suitable Use:

- Substations & switchrooms
- Utilities & power generators
- Industrial electrical maintenance & installations
- Mining, chemical & refineries



FLAME RETARDANT SOCKS

CODE: DF-9162-CH-L

- Ribbed cuff for secure fit
- Reinforced heel & toe for durability
- Blister resistant
- Thermally balanced & odour free
- Will not burn when exposed to heat & flame
80% Wool, 15% Nylon, 4% Lycra, 1% Elastane
Aflammit® ZR treated yarn

Sizes: Large (8 - 11)

Suitable Use:

- Petroleum service industry
- Petrochemical industry
- Oil & gas industry
- Electrical & gas utility
- Steel mills
- Fighter pilots





ERGOS2 ARC VISOR

CODE: ARC ERGOS3 12 / 27 & ARC ERGOS2 12-EU / 26-EU

- **Increased worker safety because of REAL VIEW of work environment.**
- New generation of face protection against the thermal hazards and impact of an arc flash
- Tested to EN 166 for protection against molten metals & hot solids
- Realistic colour reproduction >95%
- Protection against high-speed particles: medium energy impact (B)
- Extended length visor & transparent chin guard
- Optimised weight balance & no time limit on durability
- Fitted with a universal bracket for use with front brim arc rated hard hats according to EN 50365 or EN 397 standards
- Available in 12 cal/cm² & 27 cal/cm²

**AVAILABLE IN EURO HELMET SLOT MOUNTED OPTIONS:
12 cal/cm² & 26 cal/cm²**

The lens makes the difference!

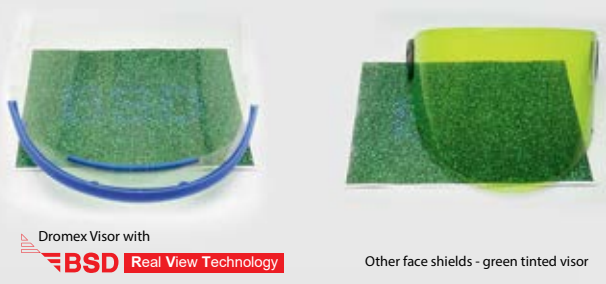

ERGOS INTEC ARC HELMET

CODE: ARC ERGOS 28

- ATPV 28 cal/cm²
- Insulated helmet with integrated retractable visor & chin protection
- Provides safety against thermal hazards of an electric arc & projected droplets of molten metal
- Electrical insulation 1000V AC & 1500V DC
- Conforms to EN 166:2001, EN 170:2002, EN 50365:2002, EN 397:2012 + A1:2012, GS-ET-29:2011 & ASTM F2178-17b
- Suitable for use by electricians during work on live equipment and work at heights on electrical connections



ARC HARD HAT

CODE: ARC HHSG 18

- Electric hard hat offering dielectric protection up to 20 000 volts
- 4-point quick fit suspension
- Adjustable Fast-Trac III ratchet
- Fixed stitched sweat band
- Easily integrated with face and hearing PPE
- Suitable for use in electric / utilities & manufacturing industries



ARC BALACLAVA



OEKO-TEX®

NFPA 70E & NFPA 2112

- 100% Meta-Aramid
- Single layer: 203gsm fabric
Double layer: 406gsm fabric
- Flame retardant thread throughout
- Lightweight & breathable

Suitable Use:

- Fire caused by -
- Chemicals
 - Petrochemicals
 - Utility/Electrical work

Sizes: One size fits all



DW-ARC9.9-BAL-S



DW-ARC31-BAL-DBL



31CAL ARC BEANIE

CODE: DW-ARC-BEAN



OEKO-TEX®

NFPA 70E & NFPA 2112

- ATPV 31 cal/cm²
- 88% Cotton, 12% Nylon Interlock FR Knitted Fabric, 406gsm
- Double layer construction for insulation
- Pleated crown area for snug fit
- Lightweight & breathable

Sizes: One size fits all

Suitable Use:

- Mining
- Petrochemicals
- Utilities & Power Generation
- Substations & Switchrooms

NEW



INTEC LED HEADLAMP

CODE: DH-INTECHL

- Cordless, rechargeable, dual light headlamp with self adhesive mounting clip
- Designed for use with the Dromex ErgoS Intec Arc Helmet (Code: ARC ERGOS 28 - Pg. 38)
- 7 Light modes LED white spotlight & COB red & white flood light
- 60 degree adjustable tilt
- Light range up to 100 meters
- Cordless with two large button switches for ease of use when wearing gloves
- IP44 water resistant up to 1 meter for 30 mins & dust proof rated
- Versatile headband for recreational use
- 1.5 - 3.5hr run time depending on light mode
- Slimline & lightweight
- USB to USB-C fast charging

Suitable Use:

- Utilities & Power Generation
- Substations & Switchrooms
- Recreational purposes (hiking, camping, riding)



16.8CAL ARC FLASH DIPPED GLOVE

CODE: NE423AF

EN 388



2341C

EN 407



41324X



ASTM

F2675/F2675M-13

D 3776:2013 Option C

- 42.3cal/cm² Arc rated palm & 16.8cal/cm² arc rated back
- Excellent grip in wet, oily & dry environments
- High dexterity
- High resistance to snatch, tear, cut, abrasion & heat
- Basic chemical oil stability
- Seamless knitted aramid fibre glove with a textured Nitrile micro foam & neoprene coated palm
- 13g Aramid flexible knit fabric
- Extended 16cm cuff

Sizes: 7 - 13

Suitable Use:

- Power & utility companies
- Installation, maintenance & repairs



51CAL LEATHER ARC GLOVE

CODE: CA420

EN 388



3X33D

EN 407



X1XXXX



ASTM

F2675/F2675M-13

- 51cal/cm² Arc rated leather gloves
- High cut level D protection
- High abrasion resistance
- High resistance to snatch, tear, cut & heat
- Multi-layer protection provides flexibility, comfort & excellent insulation
- Leather glove lined with Aramid fibre
- Kevlar stitching
- Shirred extended 16cm cuff
- Cow split leather 1mm

Sizes: 8 - 11

Suitable Use:

- Power & utility companies
- Installation, maintenance & repairs of high voltage equipment





55CAL ARC SWITCHING GLOVES

CODE: DG-ARC70



OEKO-TEX®

NFPA 2112, NFPA 70E, ASTM F2675, IEC 61482-1-1,
IEC 61482-1-2, EN 11611, EN 11612, EN 61482

- ATPV 55cal/cm²
- Dromex A.P.T Fabric - 88% Cotton, 12% Nylon
- Flame retardant glove lined with meta aramid mat lining
- Inherent FR stitching throughout
- Glove thickness: 2.7mm
- Elasticated shirred glove for comfort

Sizes: S/M & L/XL

Suitable Uses:

- Substations & switchrooms
- Utilities & power generators
- Industrial electrical maintenance & installations



100CAL ARC SWITCHING GLOVES

CODE: DG-ARC100



OEKO-TEX®

NFPA 2112, NFPA 70E, ASTM F2675, IEC 61482-1-1,
IEC 61482-1-2, EN 11611, EN 11612, EN61482, SANS 724

- APTV 100cal/cm² mitt-style glove
- Dromex A.P.T Fabric - 88% Cotton, 12% Nylon
- Triple layer construction: 14oz outer, 700gsm meta aramid mat lining & 14oz inner
- Inherent FR stitching throughout
- Elasticated shirred glove for an ideal fit
- cal/cm² Rating embroidery on cuff

Sizes: S/M & L/XL

Suitable Uses:

- Substations & switchrooms
- Utilities & power generators
- Industrial electrical maintenance & installations





NEW

40CAL METAL FREE LEATHER BELT

CODE: DW-ARCBELT



Conforms to ASTM F2621-12



- APTV 40 cal/cm²
- Metal-free, flame retardant, full grain cow leather belt
- Flame retardant adjustable hook & loop closure
- Flame retardant thread throughout
- Suitably worn with all Dromex Arc pants or jeans

Sizes: S - 3XL

Suitable Use:

- Substations & switchrooms
- Utilities & power generators
- Industrial electrical maintenance & installations

55CAL ARC BLANKET

CODE: DW-ARCBLANK



NFPA 70E & NFPA 2112

- Dromex A.P.T Fabric - 88% Cotton, 12% FR Nylon
- Two-layer panel system
 - > 14 oz Layer 1
 - > 14 oz Layer 2
- Inherent FR thread throughout
- Heat transfer print & FR APTV 55cal embroidery
- Ten double-layer loops for securing in place
- Centralised cable strap with Velcro/zip strap
- Provides protection against arc blast hazards during electrical work in confined spaces

Sizes:

- Small: 1.5m x 2.4m
- XLarge: 2.5m x 4m

Suitable Use:

- Substations & switchrooms
- Utilities & power generators
- Industrial electrical maintenance & installations
- Mining





ARC FLASH TREAD SAFETY BOOT

CODE: DF-FLASH

NRCS/9002/217251/0228



- Conforms to EN ISO 20345:2011
- Water resistant full grain cow leather upper
- Slip resistant outsole, SRC
(Slip resistance on ceramic tile floor with NaLS & on steel floor with glycerine[^]c)
- Kevlar midsole protects from penetrating objects & heat
- Energy absorbing heel
- Removable insole
- Oil resistant
- Contact heat resistant outsole at 300°C for 60 seconds
- Composite toecap is impact resistant up to 200 ± 4J
- Cleated outsole for additional traction
- Dual velcro closure strap design for ease of use with gloves

Sizes: 3 - 13

Suitable Use:

- Arc flash & flash fire potential
- Manufacturing (incl. computer equipment)
- Refineries



COMING SOON



BOLT BOOT

CODE: DF-BOLT

NRCS/9002/217251/XXXX



- Conforms to EN 20345:2022
- Water resistant, full grain cow leather upper
- Protection from electrical hazard risks of 18kV in accordance with the ASTM F2413-18 standard
- Slip resistant outsole, SR (Slip resistance on ceramic tile floor with glycerine^c)
- Kevlar midsole protects from penetrating objects & heat
- PU / Rubber outsole heat resistant outsole at 300°C for 60 seconds
- Fiberglass toecap is impact resistant up to 200 ± 4J
- Removable and breathable PU and Memory Foam insole for superior comfort
- Metal-free, lace up ankle boot

Sizes: 4 - 13

Suitable Use:

- Arc flash & electrical hazards
- Manufacturing



Dromex

FIRE





INNOVATION

POSEIDON 220 FR PROTECTION BY DROMEX

Poseidon 220: Flame Retardant Overalls

Introducing our new oil & gas overalls designed and developed to meet the exacting needs and tough challenges faced by our customers and end users working within this demanding and highly specialised sector, globally.

We know how one step closer can feel too close, how it feels to face danger every day. That's why our premium Poseidon boilersuit is HRC 2 Arc Rated, anti-static, features an action back for enhanced comfort and has adjustable sleeves & legs for a secure fit and extra pockets.

This lightweight workwear includes EN approved reflective tape around the legs, arms and over the shoulders for greater visibility.

Made with our unique Dromex F.P.T™ flame retardant fabric blend, which has been engineered to provide superior protection against heat, fire, oil and gas hazards and is proudly locally manufactured at our state-of-the-art workwear facility, Dromex Globale, situated in KZN, South Africa.

Tested to leading international NFPA, ASTM, EN & IEC standards: IEC 61482-1-1, IEC 61482-1-2, NFPA 2112, ASTM F1959, ASTM F2621-12, EN 11611, EN 11612 & EN 61482.

Encompassing both European ISO/EN norms and US NFPA standards, our new Poseidon 220 range maximises stock control, enabling suppliers and distributors to participate in all major PPE regions around the world.

Therefore, Poseidon 220 fabrics offer much greater value and flexibility in diverse market conditions.

In addition to achieving these European and US technical standards, Poseidon 220 fabrics have also come with Oeke-Tex Class II level for formaldehyde requirements, distinguishing this new range as a complete and total package of Flame Retardant Fabrics, with global market application.

Innovatively developed to deliver optimum protection, the Poseidon 220 range offers the ultimate combination of superb technical and aesthetic product quality and certified standards supported with versatile delivery options and excellent customer service.

POSEIDON 220

98% Cotton, 2% Anti-static

220 gr/m²

Certified to: EN 11611, EN 11612, EN 1149, EN 61482, ASTM, NFPA

Dual certified to NPFA / EN norms

Low formaldehyde: Class II - below 73 ppm formaldehyde

Global market application

Maximized stock control: no need to have different certified fabrics for different markets, offering more flexibility.

We believe that all employees are entitled to maximum protection without compromise. From essential PPE to our specialised FIRE protection, it is our responsibility to supply products that will deliver on this promise.



**Two-Piece Suit
Coming Soon**

**Dromex
FIRE**



POSEIDON OIL & GAS BOILERSUIT

CODE: DW-POS220RT



IEC 61482-1-1, IEC 61482-1-2, NFPA 2112, ASTM F1959
ASTM F2621-12, EN 11611, EN 11612, EN 61482

- Dromex F.P.T™ Fabric - 98% Cotton, 2% Anti-static, 220gsm
- ATPV 8 cal/cm²
- Inherent flame retardant thread
- Action back design with pleats for extra comfort & freedom of movement
- Flame retardant hook & loop strip above right chest pocket for attachment of a name badge
- Concealed nylon zip with branded puller & nylon press stud closure at front
- 50mm Silver FR reflective EN approved tape on shoulders, arms & legs
- Triple needle topstitched garment
- Mitred breast & back pockets with flaps & concealed FR hook & loop closure
- Left shoulder tape has a gas detector/radio loop with concealed FR hook & loop
- A pen pocket on left sleeve
- Waist side swing pockets with inner side opening
- Side tool pocket
- Adjustable sleeve cuff & leg hem with nylon press stud

Sizes: 32 - 64

Suitable Use:

- Oil & gas
- Refineries

OR

RB

RD

NB



Dromex
FIRE



DuPont™
Nomex®
FIRE SUIT

CODE: DW-NOMEX-J / P



Conforms to SANS 434
NFPA 70E, NFPA 1975, NFPA 2112,
EN1149-3 ANTI-STATIC, EN 1149-1, EN 13034
ASTM F1506, ASTM D6413 Flame resistance of textiles

- DuPont™ Nomex, 203gsm Fabric
- Inherent flame retardant yarn
- NOMEX YKK concealed brass zips on jackets & pants
- Triple needle topstitched garment
- 50mm Silver flame retardant reflective tape on arms & legs for increased visibility
- Mitred laid on jacket pockets, mitred breast pocket with Velcro closure, side slits, hip pocket & mitred cargo pocket both with Velcro flap on pants & one back pocket

Sizes:

- Jackets: 32 - 60
- Pants: 28 - 56

Suitable Use:

- Petroleum
- Petrochemical
- Chemical
- Fire fighters



DuPont™
Nomex®
FIRE BOILERSUIT

CODE: DW-NOMEX-O



Conforms to SANS 434
NFPA 70E, NFPA 1975, NFPA 2112,
EN1149-3 ANTI-STATIC, EN 1149-1, EN 13034
ASTM F1506, ASTM D6413 Flame resistance of textiles

- DuPont™ Nomex, 203gsm Fabric
- Inherent flame retardant yarn
- Two-way NOMEX YKK concealed brass zip
- 50mm Silver flame retardant double needle topstitched reflective tape on arms & legs
- Fully triple needle topstitched garment
- Two-way radio pocket with 25mm Velcro, mitred breast pocket with velcro V-flap & gas analyser tab, side pockets, two mitred back pockets with Velcro monza flap

Sizes: 32 - 64

Suitable Use:

- Petroleum
- Petrochemical
- Chemical
- Fire fighters





WILDLAND GOGGLES

CODE: DV-EF20B



- Fire resistant polycarbonate lens
- Fire proof adjustable headband
- Red fire retardant PVC eye frame
- Designed for compatibility with other PPE
- Easy to put on with gloves
- Lightweight, non-vented goggles
- Anti-Scratch
- Anti-fog lens
- Contoured to ensure a firm fit
- Provides protection from flying debris

- Complies to ASTM F2894 for heat resistance up to 260°C, 6/ -0°C (8,4,6)
- NFPA 1977:2016
- ANZI Z87 NFPA 1971 & 1977

Suitable Use:

- Fire marshal
- Bush fires
- Work around active helicopters
- Extrication
- Working with chain saws / hoses
- Emergency / first responder operations
- Chemical splash



BALACLAVA

CODE: DW-BALAS / D



NFPA 70E & NFPA 2112

DW-BALAS: Single Layer
DW-BALAD: Double Layer

- Inherent knitted fabric
- 100% Meta-Aramid
- 190gsm fabric
- Flame retardant thread throughout
- Lightweight & breathable

Suitable Use:

Fire caused by -

- Chemicals
- Petrochemicals
- 190gsm fabric
- Utility/electrical work

Sizes: One size fits all



FIRE & CHEMICAL BOOTS

CODE: DFB



EN 15090:2012 approved

- Lightweight firefighting boots
- Suitable against chemicals & can be worn with chemical encapsulated suits
- Has the highest chemical protection, Type 3 (fire suppression, rescue interventions including protection against chemical hazards)
- Reflective strips & trim can be seen as far as 250m away
- Rot proof inner lining
- Made of Elastomer: fireproofed NBR/CR (fireproofed nitrile/polychloroprene rubber)
- EN 15090 approved firefighting boots and Marine Fire Protection certified, used in many European countries
- 10 Year shelf life
- Composite polymer toe cap & midsole for impact & puncture protection (ladies sizes 3 & 4 ½ has a steel toe cap)
- Weight (size 8): 1900g per pair

Suitable Use:

- Structural & wildland fire fighting applications
- Search & Rescue
- Aircraft fires
- Petrochemical fires

Sizes: 3 - 11 ½

**Ladies size options available*

SIZING GUIDE

EUR	36	37/38	39	40/41	42	43	44	45	46/47
UK	3	4 ½	5 ½	7	8	9	9 ½	10 ½	11 ½



WORKWEAR



Dromex



HYBRID SUIT

CODE: DW-HYB-RB



- 80/20 Poly Cotton, 200gsm fabric
- Concealed DRO aluminium zip on jackets & pants
- Triple needle topstitched inleg & back rise
- Polyester for colour-fastness blended with cotton for comfort & breathability
- Left breast pocket
- Side entry pants pockets

HYBRID-RT:

- 50mm Lime/silver/lime reflective webbing tape on arms & legs
- Sold as a set

HYBRID SUIT REFLECTIVE

CODE: DW-HYBRT-RB



Sizes: 32 - 50

Suitable Use:

- Construction
- Landscaping
- General purpose
- Maintenance



CONTI SUIT

CODE: DW-CONTI



- 80/20 Poly Cotton, 200gsm fabric
- Concealed DRO aluminium zip on jackets & pants
- Overlocked stitching on shoulders and armholes
- Triple needle topstitched inleg & back rise
- Left breast pocket with pen division & V-flap with concealed press stud
- Side entry pants pockets
- Right back pocket
- Reinforced bar-tacks
- Polyester for colour-fastness blended with cotton for comfort & breathability

CONTI SUIT RT

CODE: DW-CONTI-RT



- Sold as a set

DW-CONTI-RT:

- 50mm Lime/silver/lime reflective webbing tape on arms & legs

Sizes: 30 - 64

Suitable Use:

- Warehouses
- Workshops
- Gardening
- Construction
- Janitorial
- General purpose

NEW

MAXIMUS CONTI SUIT

CODE: DW-MAXIMUS



- 80/20 Poly Cotton, 200gsm fabric
- Concealed DRO zip closures
- Triple needle topstitched jacket shoulders, armholes and side seams
- 2 Open laid on waist pockets, 1 open left chest pocket with a pen pocket and 1 right breast pocket with a V-flap and a concealed metal press stud closure.
- Two front pants swing pockets and an open mitred back pocket
- All pant seams are triple stitched for added durability
- Inner elasticated waist for optimum fit and flexibility with 7 belt loops
- Ruler/tool pocket on rear right leg
- Generous cut made with Polyester & Cotton blend for colour-fastness, comfort & breathability.
- Sold as a set

Sizes: 30 - 60

Suitable Use:

- Logistics
- Warehousing
- Construction
- Workshops, maintenance & repairs
- Gardening & general-purpose applications

RB

NB

RD

EG





80/20 DUST COAT

CODE: DW-8020XX-DC



- 80/20 Poly Cotton, 200gsm fabric
- Concealed metal press stud closures
- Triple needle topstitched shoulders and armholes
- Left breast mitred pocket & V-flap with concealed press stud
- 2 mitred waist pockets
- Slit at back centre back hem
- Polyester blended with Cotton for colour-fastness, comfort & breathability.

Sizes: XS - 3XL

Suitable Use:

- Laboratories
- Hospitals
- Warehousing
- General supervision in industries

RB

NB

WHT

NEW

HACCP JACKET & PANTS

CODE: DW-HACCP-XX-J / P



- 65/35 Poly Cotton, 235gsm fabric
- Pull over jacket with a V-neck chest and collar
- Triple stitched jacket shoulders, armholes and side seams
- Left breast internal pocket
- Partially elasticated jacket sleeve cuffs
- Triple stitched, elasticated pants with drawstring
- Pants back pocket with flap closure
- Polyester blended with Cotton for colour-fastness, comfort & breathability.

Sizes:

- Jackets: 30 - 60
- Pants: 26 - 56

Suitable Use:

- Food Industry





HACCP DUST COAT

CODE: DW-HACCP-XX-DC



- 65/35 Poly Cotton, 235gsm fabric
- Double concealed press stud closures
- Triple stitched shoulders, armholes and side seams
- Left breast internal pocket
- Back slit on rear of coat for flexibility and ease of movement
- Partially elasticated sleeve cuffs
- Polyester blended with Cotton for colour-fastness, comfort & breathability.

Sizes: XS - 3XL

Suitable Use:

- Food Industry

WHT

RB

NB

RD

65/35 SANS 434 FIT JACKET & PANTS

CODE: DW-6535XX-J / P



- 65/35 Poly Cotton, 235gsm fabric
- Concealed DRO aluminium zip on jackets & pants
- Triple needle topstitched garment
- 2 Mitred breast pockets with V-flaps & concealed press stud closure, left breast pocket with pen division
- 2 Open mitred waist pockets
- 2 Side swing pockets and 2 rear mitred open pocket on pants
- Side tool pocket
- Polyester blended with Cotton for colour-fastness, comfort & breathability.
- Jackets & pants sold separately

Sizes:

- Jackets: 30 - 60
- Pants: 26 - 56

Suitable Use:

- Logistics
- Warehouses
- Workshops
- Gardening
- Construction
- General purpose
- Maintenance & repairs





65/35 TWO-TONE JACKET

CODE: DW-6535XX-2TJ



- 65/35 Poly Cotton, 235gsm fabric
- Concealed DRO aluminium zip
- Triple needle topstitched garment
- 2 Mitred breast pockets with V-flaps & concealed press stud closure, left breast pocket with pen division
- 2 Open mitred waist pockets
- Polyester blended with Cotton for colour-fastness, comfort & breathability.

Sizes: XS - 5XL

Suitable Use:

- Farming & Agriculture
- Warehouses
- Workshops
- Construction
- General purpose
- Maintenance & repairs



NEW



KH

CA



UTILITY PANTS & SHORTS

CODE: DW-UTI-PN (PANTS)
DW-UTI-SH (SHORTS)

- 65/35 Poly Cotton & 300D water-resistant 100% Polyester Oxford, 280gsm
- Concealed nylon zip
- Triple needle topstitched garment
- Multifunctional custom pockets (ruler/pen-pocket, mobile phone pocket & cargo pocket)
- Reflective piping on rear ankle, knee area and back pockets
- Hammer/tool loop
- Concealed elasticated waistband
- Reinforced canvas panels for added durability

- Polyester blended with Cotton for colour-fastness, comfort & breathability

Sizes: 28 - 50

Suitable Use:

- General purpose
- Maintenance & repairs
- Workshops
- Logistics
- Rigging



BE THE ONE WHO GETS IT DONE.

OUR NEW TECHNICAL UTILITY RANGE IS **IN STOCK** NOW!

The new versatile and multifunctional Dromex Technical Utility range has been engineered to perform so you can be the one who gets it done.

Some premium features include:

- Multifunctional custom pockets (ruler/pen pocket, mobile phone pocket and cargo pocket).
- Reflective piping on rear leg pockets, rear ankle and knee area for added visibility in dark environments.
- Hammer/tool loop.
- Seams are triple needle topstitched for added durability.
- Stress areas are bar tacked.
- Inner elasticated waist for optimum fit and flexibility with 7 belt loops.
- Reinforced canvas panels and a comfortable spacious crouch area for ease of movement.
- Available in 2 contrasting colours, Sand and Carbon.

We're committed to supplying quality without compromise and this promise is at the forefront of every piece of Dromex Workwear.



Dromex

NEW

UTILITY JACKETS

CODE: DW-UTI-J

- 65/35 Poly Cotton & 300D water-resistant
100% Polyester Oxford, 280gsm
- Multifunctional custom pockets 2 waist pockets with zip closure
- 2 chest pockets with hook and loop closure:
 - left pocket has multiple pens pocket
 - right pocket with a concealed side entry pocket & zip fastener, an inner mobile phone pocket with hook and loop fastening
- A pen/ruler pocket on the left arm
- Adjustable sleeve cuffs
- Adjustable waist band with press stud fasteners.
- Action back pleats at rear of jacket for comfort and flexibility
- Reflective piping for enhanced visibility
- Stress points are bar tacked

Sizes: S - 3XL

Suitable Use:

- General purpose
- Maintenance & repairs
- Workshops
- Logistics
- Rigging

KH

CA





KNEE PAD TECHNICAL UTILITY PANTS

CODE: DW-UTI-KPN-BLK

- 65/35 Poly Cotton & 300D water-resistant 100% Polyester Oxford, 280gsm
- Top loading pre-shaped knee pad pockets for use with Dromex knee pads (DW-UTI-KPAD)
- Concealed nylon zip
- Triple needle topstitched garment
- 10 Multifunctional custom pockets (tool pockets, ruler/pen-pocket, mobile phone pocket & cargo pocket)
- Reflective piping on knee, back pockets and cargo pockets
- Hammer/tool loop
- Concealed elasticated and rubberised waistband
- Reinforced canvas panels for added durability
- Polyester blended with Cotton for colour-fastness, comfort & breathability

Sizes: 28 - 50

Suitable Use:

- General purpose
- Maintenance & repairs
- Workshops
- Logistics
- Rigging



TECHNICAL UTILITY KNEE PADS

CODE: DW-UTI-KPN-BLK

- Ergonomically designed to adapt to the shape of the knees while bending
- Shock absorbent
- Lightweight, soft & durable
- Can be cut to size as required
- Sold separately

Sizes: One size

NEW



FLAME ACID TECHNICAL UTILITY JACKET & PANTS

CODE: DW-UTI-PN / J-AB

EN 6530:2005 EN 14116:2015



100%
COTTON

- 100% Cotton fabric, 280gsm
- A flame retardant & coated acid resistant fabric
- Multifunctional custom pockets 2 waist pockets with zip closure
- 2 chest pockets with hook and loop closure:
 - left pocket has multiple pens pocket
 - right pocket with a concealed side entry pocket & zip fastener, an inner mobile phone pocket with hook and loop fastening
- A pen/ruler pocket on the left arm
- Adjustable sleeve cuffs
- Adjustable waist band with press stud fasteners.
- Action back pleats at rear of jacket for comfort and flexibility
- Reflective piping for enhanced visibility
- Stress points are bar tacked
- Jackets & pants sold separately

Sizes:

- Jackets: S - 5XL
- Pants: 28 - 50

Suitable Use:

- Engineering
- Construction
- Welding
- Maintenance & repairs





QUICK DRY T-SHIRTS

CODE: DW-TECH-T



POLYESTER

- 100% Polyester, 140gsm fabric
- Premium crew neck t-shirt
- Lightweight polyester moisture management fabric for added comfort
- Quick drying garment
- The natural fibres & relaxed fit design makes this garment comfortable & breathable
- Available in five colours

Sizes: XS - 5XL

Suitable Use:

- Corporate wear
- Promotional wear
- Active wear
- General work environments
- Warehouses



NEW

QUICK-DRY GOLFERS

**CODES: DW-HVTECH-G (HI-VIZ)
DW-TECH-G (COLOURS)**

- 100% Polyester, 140gsm fabric
- Quick dry, short sleeve collared golf shirts with button closure
- Double needle stitched cover seams
- Rib knit collar
- Side slits
- Unisex style
- Comfortable & breathable

Sizes: XS - 5XL

Suitable Use:

- Warehouses
- General work environments
- Corporate wear
- Promotional wear
- Active wear



REFLECTIVE SHIRTS

CODE: DW-HVSS / LS

**100%
COTTON**

- 100% Cotton, 135gsm fabric
- Reflective operational shirt
- Vented back yoke for comfort in heat
- 50mm Silver reflective tape on sleeves, around the chest & waist
- Mitred pockets have double needle topstitching
- Button closure
- The natural fibres make this garment comfortable & breathable
- Ideal with navy J54 Cargo Pants or Dromex Denims

NOTE:

- Two-tone shirts orange/navy & yellow/navy available in short sleeve & long sleeve
- Navy available in long sleeve only

Sizes: S - 5XL

Suitable Use:

- Construction
- Outdoor inspections
- Outdoor work in hot climates
- Mining



J54-RT CARGO PANTS SABS SPEC

CODE: DW-CARGO-PRT

**100%
COTTON**



- 100% Cotton, 220gsm fabric
- YKK concealed brass zip
- Fully triple stitched trousers
- Mitred cargo pockets with mitred flap & hook & loop closure
- Right cargo pocket includes cell phone division
- 50mm Silver reflective tape on legs
- The natural fibres make this garment comfortable and breathable

Sizes: 26 - 50

Suitable Use:

- Construction
- Logistics
- General purpose



ACID RESISTANT CONTI SUIT

CODE: DW-ACID



Protection from the following chemicals:
HNO₃, HCl, H₂SO₄ & NaOH

- 80/20 Poly Cotton, 200gsm fabric
- YKK concealed metal zip on jackets and pants
- Triple topstitched shoulders, armholes, in-leg & back rise
- Left breast pocket with pen division & V-flap
- Side entry pants pockets & rear right pocket
- A coated acid resistant fabric that doesn't allow wetting by acids or moisture
- Protection in the event of accidental chemical spillage
- Sold as a set

Sizes: 30 - 60

Suitable Use:

- Chemical industry
- Cleaning industry
- Brewing industry





POLY VISCOSE ACID JACKET & PANTS RT

CODE: DW-PVACID-RT



SANS 434 & ISO 6530

Protection from the following chemicals:
HCl, H₂SO₄, N₉OH, Caustic Soda

- 80/20 Poly Viscose, 270gsm fabric
- YKK Concealed brass zip on jackets & pants
- Full triple needle topstitched garment
- Mitred left breast pocket & jacket pockets
- Side entry pants pockets & rear right pocket
- 50mm Lime/silver/lime reflective webbing tape on arms, chest, legs & an "X" on the back
- A coated acid resistant fabric that prevents wetting by acids or moisture
- Protection in the event of accidental chemical spillage
- Jackets & pants sold separately

Sizes:

- Jackets: 32 - 64
- Pants: 28 - 60

Suitable Use:

- Chemical industry
- Cleaning industry
- Brewing industry
- Mining industry

J54 100% COTTON JACKET & PANTS

CODE: DW-J54XX-J / P



- 100% Cotton, 220gsm fabric
- Concealed DRO aluminium zip on jackets & pants
- Triple needle topstitched garment
- Double needle topstitched yokes
- Mitred left breast pocket with V-flap & two open mitred waist pockets
- Swing pockets on pants & rear right pocket
- The natural fibres make this garment comfortable & breathable
- Jackets & pants sold separately

Sizes:

- Jackets: 32 - 64
- Pants: 26 - 60

Suitable Use:

- Agriculture
- Construction
- Logistics
- General work environments





DENIM JACKET & PANTS SANS 434 FIT

CODE: DW-DENIM-J / P



- 100% Cotton indigo blue denim, 12oz fabric
- YKK Concealed brass zip on jackets & pants
- Full triple needle topstitched jacket & pants
- Rounded left breast pocket and two front jacket pockets with mitred flaps
- Bar-tacks on all stress points
- Rounded back pocket & side entry pants pockets
- Tool pocket on the back right leg
- The natural fibres make this garment comfortable & breathable
- Jackets & pants sold separately

Sizes:

- Jackets: 30 - 64
- Pants: 26 - 60

Suitable Use:

- Construction
- Engineering
- Steel foundry
- Automotive

J54 RT MINING SPEC BOILERSUIT

CODE: DW-J54-ANGXX / UB



Compliant to SANS 434 & SANS 1387-4

- 100% Cotton, 220gsm fabric
- 6 Pocket artisan boilersuit
- 50mm Lime/silver/lime reflective tape with double needle topstitching around arms, legs, strips above breast pocket & "X" on the back
- Concealed NG5 metal button closure
- Full triple needle topstitched garment
- 2 x Mitred breast pockets with monza NG5 metal button flaps
- Concealed elasticated waistband
- Side swing pockets & slits
- Mitred back pocket
- Side tool pocket on right leg
- The natural fibres make this garment comfortable & breathable

Sizes:

- Royal blue: 30 - 64
- Other colours: 30 - 66

Suitable Use:

- Mining
- Agriculture
- Construction
- Logistics





J54 RT MINING SPEC JACKET & PANTS

CODE: DW-J54-ANGXX

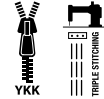

Compliant to SANS 434 & SANS 1387-4

- 100% Cotton, 220gsm fabric
- YKK Concealed brass zip on jackets & pants
- 50mm Lime/silver/lime reflective tape around arms, legs, strips above breast pocket & "X" on the back
- Full triple needle topstitched garment
- Mitred left breast pocket with press stud closure & mitred flap
- Two open mitred waist pockets
- Ruler pocket
- The natural fibres make this garment comfortable & breathable
- Jackets & pants sold separately

Sizes:

- Jackets: 32 - 64
- Pants: 28 - 60

Suitable Use:

- Mining
- Agriculture
- Construction
- Logistics
- Engineering

RB

RD

YL



D59 RT MINING SPEC BOILERSUIT

CODE: DW-D59-ANGUB-B



Compliant to SANS 434 & SANS 1387-4

- *Premium Mining Garment*
 - 100% Cotton, 270gsm - D59 unbleached
 - Double thickness patches on elbows, seat & knees for enhanced durability
 - 50mm Lime/silver/lime reflective tape with double needle topstitching around arms, legs, strips above breast pocket & "X" on the back
 - Concealed metal button closures
 - Full triple stitched garment
 - 2 x Mitred breast pockets with monza NG5 metal button flaps
 - Concealed elasticated waistband
 - Side swing pockets & slits
 - Mitred back right pocket
 - Side tool pocket on right leg
 - The natural fibres make this garment comfortable & breathable
- *Also available with 50mm silver tape*

Sizes: 30 - 64

Suitable Use:

- Mining
- Construction





D59 MINING BOILERSUIT

CODE: DW-D59-ANGRT-B-YL

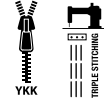

Compliant to SANS 434 & SANS 1387-4

- 100% Cotton, 270gsm Fabric
- Two-way YKK concealed brass zip
- Full triple needle topstitched garment
- 50mm Silver reflective tape over shoulders, around arms, around legs & 50mm flame retardant orange reflective tape on back
- Left breast pocket with V-flap, concealed press stud closure & pen division on top of flap.
- Cargo pocket with concealed press stud V-flap & patch back hip pocket
- The natural fibres make this garment comfortable & breathable

Sizes:

- White: 32 - 64
- Yellow & Orange: 30 - 64

Suitable Use:

- Mining
- Steel installations
- Rigging

D59 RT JACKET & PANTS

CODE: DW-D59RT-J / P



Compliant to SANS 434 & SANS 1387-4

- 100% Cotton, 270gsm fabric
- YKK Concealed brass zip on jackets & pants
- 50mm Lime/silver/lime reflective tape around arms & legs with double needle topstitching
- Full triple needle topstitched garment
- Mitred left breast pocket with press stud closure & mitred flap
- Two open mitred waist pockets
- Front swing pants pockets
- Rear mitred right pocket
- Ruler pocket on right leg
- The natural fibres make this garment comfortable & breathable

- Jackets & pants sold separately

Sizes:

- **Jackets:** 32 - 62
- **Pants:** 28 - 58

Suitable Use:

- Mining
- Agriculture
- Construction
- Engineering
- Steel installations
- Rigging





D59 FLAME RT JACKET & PANTS

CODE: DW-FLAMERT-J / P



Compliant to SANS 1387-4, SANS 1423-1 & SANS 434

- 100% Cotton, 320gsm fabric
- YKK Concealed brass zip on jackets & pants
- Triple needle topstitched garment
- Left breast pocket with concealed press stud
- Two open mitred waist pockets
- Front swing pants pockets
- Rear mitred right pocket
- 50mm Lime/silver/lime reflective webbing tape on arms, legs, chest & back
- The natural fibres make this garment comfortable & breathable
- A flame retardant finish coated fabric
- Reflective tape for visibility

- Jackets & pants sold separately

Sizes:

- Jackets: 30 - 64
- Pants: 26 - 60

Suitable Use:

- Construction
- Welding
- Boiler shops
- Foundry
- Heavy engineering

D59 FLAME & ACID JACKET & PANTS

CODE: DW-D59FA-J / P



SANS 434, SANS 1387-4, SANS 1423-1,
ISO 6530 (HNO₃, HCl, H₂SO₄ & NaOH)

- 100% Cotton, 320gsm fabric
- A flame retardant & coated acid resistant fabric
- 50mm Silver flame retardant double needle topstitched reflective tape on arms & legs
- YKK Concealed brass zip on jackets & pants
- Mitred laid on jacket pockets, mitred breast pocket with flap, mitred hip pocket & tool pocket on pants
- Double needle topstitched mitred back pocket
- Full triple needle topstitched garment
- Elasticated cuffs & side slits on jacket
- The natural fibres add comfort & breathability
- Protection in the event of a flash fire, and accidental chemical spillage
- Jackets & pants sold separately

Sizes:

- Jackets: 28 - 68
- Pants: 24 - 64

Suitable Use:

- Petrochemical, oil & gas
- Mining industry
- Maintenance & repairs including installations
- Utilities & power generators





D59 FLAME & ACID BOILERSUIT

CODE: DW-D59FA-O



SANS 434, SANS 1387-4, SANS 1423-1,
ISO 6530 (HNO₃, HCl, H₂SO₄ & NaOH)

- 100% Cotton, 320gsm fabric
- A flame retardant & coated acid resistant fabric
- 50mm Silver flame retardant with double needle topstitched reflective tape on arms & legs
- YKK concealed brass zips with 2 way slider
- 2 Breast pockets with V-flap
- 2 Hip side pockets & side tool pocket
- 1 Back hip pocket
- Full triple needle topstitched garment
- Elasticated cuffs
- The natural fibres add comfort & breathability
- Protection in the event of a flash fire and accidental chemical spillage

Sizes: 28 - 74

Suitable Use:

- Petrochemical, oil & gas
- Mining industry
- Maintenance & repairs including installations
- Utilities & power generators

LADIES D59 FLAME & ACID JACKET & PANTS

CODE: DWL-D59FA-J / P



SANS 434, SANS 1387-4, SANS 1423-1,
ISO 6530 (HNO₃, HCl, H₂SO₄ & NaOH)

- SANS 434 Ladies cut & design
- 100% Cotton, 320gsm fabric
- A flame retardant & coated acid resistant fabric
- 50mm Silver flame retardant double needle topstitched reflective tape on arms & legs
- YKK Concealed brass zip on jackets & pants
- Mitred laid on jacket pockets, mitred breast pocket with flap, mitred hip pocket & tool pocket on pants
- Side slits for comfortable fit over waist
- Double needle topstitched mitred back pocket
- Full triple needle topstitched garment
- Elasticated cuffs
- The natural fibres add comfort & breathability
- Protection in the event of a flash fire, and accidental chemical spillage
- Jackets & pants sold separately

Sizes:

- Jackets: S - 5XL
- Pants: S - 5XL

Suitable Use:

- Petrochemical, oil & gas
- Mining industry
- Maintenance & repairs including installations
- Utilities & power generators





D59 FLAME ACID SAFETY OFFICERS JACKET & PANTS

CODE: DW-D59FAOR-J / P



SANS 434, SANS 1387-4, SANS 1423-1
ISO 6530 (HNO₃, HCl, H₂SO₄ & NaOH)

- 100% Cotton, 320gsm fabric
- YKK concealed brass zip on jackets & pants
- Full triple needle topstitched garment
- 50mm Silver flame retardant reflective tape
- Elasticated cuffs & side slits on jacket
- Mitred laid on jacket pockets & breast pocket with V-flap
- The natural fibres add comfort & breathability
- A flame retardant & coated acid resistant fabric
- Reflective tape for increased visibility
- Protection in the event of a flash fire and accidental chemical spillage
- Jackets & pants sold separately

Sizes:

- Jackets: 30 - 60
- Pants: 26 - 56

Suitable Use:

- Petrochemical
- Oil & Gas
- Mining industry
- Maintenance & repairs including installations
- Utilities & power generators

ESKOM SPEC D59 FLAME JACKET & PANTS

CODE: DW-D59ESKOM



SANS 434, SANS 1387-4, SANS 1423-1

Compliant according to the Eskom PPE Specification 240-44175132.

Manufactured in RSA with DA GAMA locally produced fabric

- 100% Cotton, 315gsm flame treated fabric
- Eskom pantone navy blue jacket & pants with "Eskom" and "Zero Harm" embroidery
- 50mm Silver retro-reflective flame retardant tape double needle topstitched on arms & legs
- Concealed heavy duty Vizlon zip & plastic press stud closure
- Mitred laid on jacket pockets, mitred left breast pocket with flap & button closure.
- Two side entry pants pockets with money pocket & mitred back pockets.
- Full triple needle topstitched garment
- The natural fibres add comfort & breathability
- Protection in the event of accidental flame contact
- Jackets & pants sold separately

Sizes:

- Jackets: 28 - 64
- Pants: 24 - 60

Suitable Use:

- Eskom Distribution, Transmission, Generation & Rotek operations in compliance with Eskom group specification





D59 FLAME ACID THERMAL JACKET

CODE: DW-D59FA-WJ



SANS 1387-4, SANS 1423-1
ISO 6530 (HNO₃, HCl, H₂SO₄ & NaOH)

- 100% Cotton
- 320gsm Flame & acid retardant fabric outer
- 100gsm Flame retardant wadding interlining
- 220gsm Flame retardant lining
- YKK chunky nylon zip
- Double needle topstitched on shoulders & armholes
- Flame retardant 50mm silver reflective tape on arms
- Adjustable size flap on cuff
- Two square breast pockets with press studded flaps
- Two outer square bottom pockets with press studded flaps
- Nickel press studs throughout

Sizes:

- Navy blue: XS - 7XL
- Orange: XS - 3XL

Suitable Use:

- Petrochemical
- Oil & gas
- Mining industry
- Utilities & power generators
- Maintenance & repairs including installations

NB

OR



WELDING JACKET

CODE: DB-WELDJ

- Flame retardant 100% Cotton jacket with premium leather sleeves
- Flame resistant Kevlar thread for durable seams
- Adjustable, stand-up, collar for neck protection
- Flame retardant reflective "X" tape on back
- Adjustable waist for enhanced torso fit
- Protects the torso & arms from welding spatter & burns
- Comfortable, breathable & lightweight

Sizes: S - 2XL

Suitable Use:

- Welding applications with exposure to intense sparks





Protera™

12.4_{CAL} PROTERA ARC JACKET & PANTS

CODE: DW-PROT12.4-J / P



NFPA 70E Cat 2 ATPV RATING
ASTM F1959 ATPV 12 4, NFPA 2112

- ATPV 12.4 cal/cm²
- DuPont™ Protera®, 270gsm Fabric
- Engineered flame retardant yarn
- YKK Concealed brass zips on jackets & pants
- Adjustable Velcro closure
- Triple needle topstitched shoulder, armhole, inleg & back rise seams
- Flame retardant Velcro closure side slits on hem of trouser
- Nomex knitted rib cuffing
- Protera sidewinder
- Side entry pockets on jackets & pants
- 12.4 cal/cm² Rating embroidery on jacket & pants
- Jackets & pants sold separately

Sizes:

- Jackets: 32 - 60
- Pants: 28 - 56

Suitable Use:

- Electrical arc flash



D59 FLAME & ACID WELDERS HOOD

CODE: DW-D59FAWH-NB



SANS 434, SANS 1387-4, SANS 1423-1,
ISO 6530 (HNO₃, HCl, H₂SO₄ & NaOH)

- 100% Cotton, 320gsm fabric
- A flame retardant & coated acid resistant fabric
- The natural fibres add comfort & breathability
- Protection in the event of a flash fire and accidental chemical spillage

Sizes: Standard one size (S"M)

D59 FLAME & ACID WELDERS SKULL CAP

CODE: DW-D59FASCN



SANS 434, SANS 1387-4, SANS 1423-1,
ISO 6530 (HNO₃, HCl, H₂SO₄ & NaOH)

Suitable Use:

- Engineering
- Smelting operations
- Mining industry
- Construction
- Oil & gas
- Petroleum
- Maintenance & repairs
- Welding industries



Dromex

HEAD & FACE PROTECTION



CODE: DH-HH
Available colours:



CODE: DH-HHCL
Available colours:



HARD HATS



- Polypropylene copolymer hard hat
- Retractable ventilation holes
- Ratchet type adjustment for easy fitment
- 2-Point adjustable webbed polyester chin strap
- Side slots for fitment of face & hearing PPE
- 8-Point suspension within the shell provides optimum shock absorption
- Anti-static & tested for electrical isolation at 2000 volts
- Complies with the requirements of SANS 1397:2003, Industrial Safety Helmets
- Certified to EN 397:2012+A1:2012, Industrial Safety Helmets
- MASC 20-8361 approved, Mining and Surface Certified as per 2015/021934/07
- CE Approved

- Available with an optional lamp mounting bracket with cord holder (DH-HHCL-W) (*Cap lamp not included*)

Suitable For Use In:

- Warehousing
- General & road construction
- Surface mining
- Utilities - General working at height
- Petrochemical & refineries
- Forestry

 **PROUDLY PRODUCED
IN SOUTH AFRICA**



BUMP CAPS

CODE: BUMPCAP

- 80% Cotton 20% Polyester Bump Cap
- Ventilated, baseball cap style
- Conforms to EN 812

NB

BK



HH CARRIER VISOR

CODE: DH-HHCARRIER



EN 166

- Polycarbonate visor & ABS brow guard
- Universal face shield compatible with most industrial safety hard hats/helmets
- Provides face protection against liquid splash, medium impact particulates, molten metal & resistance to hot solids
- Suitable in construction, general industry, mining, oil & gas, utilities, airports, machining, grinding, woodwork & drilling applications



MARTCARE

CODE: DH-MARTCARE



- Polycarbonate visor & brow guard carrier
- Elasticated adjustable headband
- Adjustable tilt & engage mechanism
- Provides protection against flying objects, particles, chemical splashes, splashes of molten metals & penetration of hot solids.
- Compatible for use with half mask respiratory protective devices
- Approved to EN 166



SPLASH GUARD

CODE: DH-FT2910

- A double sided, anti-fog PET Visor
- A 180° wide range isolation protection
- Transparent high definition optically correct vision
- Soft foam brow guard
- Elasticated latex-free adjustable headband
- Compatible for use with half mask respiratory devices & spectacles
- Commonly used in medical/healthcare environments and for oil and dust exposure.
- Also suitable for use in laboratories, domestic and public places.



RESPIRATORY PROTECTION



Dromex



Dromex

BREATHE EASY

CHOOSING RESPIRATORY PROTECTION

CONSIDERATIONS FOR MASK SELECTION:

- What is the oxygen content?
- Are there asphyxiants present?
- Is the atmosphere immediately dangerous to life or health?
- Is the atmosphere corrosive or likely to become so?
- Is the atmosphere explosive or likely to become so?
- Is there the possibility of permeation of air contaminants?
- What is the contaminant?
- Are there climatic extremes?

Standard	Description	Class	NPF Nominal Protection Factor	APF Assigned Protection Factor
EN 149	Filtering half mask	FFP1 FFP2 FFP3	4 12 50	4 10 20
EN 405	Valve filtering half mask	FF Gas X P1 FF Gas X FF Gas X P2 FF Gas X P3	4 50 12 33	4 10 10 10
EN 140 (Mask) EN 143 EN 14387 EN 12083	Half mask and quarter mask with filter	P1 P2 P3 Gas X Gas X P1 Gas X P2 Gas X P3	4 12 48 50 4 12 48	4 10 10 10 4 10 10
EN 136 EN 143 EN 14387 EN 12083	Full face mask (all classes)	P1 P2 P3 Gas X Gas X P1 Gas X P2 Gas X P3	5 16 1000 2000 5 16 1000	4 10 40 20 20 20 20

Particulate, Gas & Vapour Filter Selection continued on Page 87....

DISPOSABLE CUP SHAPE RESPIRATORS



QSA 2010 - FFP1
(NRCS AZ2006/21)



QSA 2020 - FFP2
(NRCS AZ2006/20)



QSA 2021 - FFP2 (VALVED)
(NRCS AZ2006/29)

QSA DUST MASKS

- Suitable for a single 8-hour use against solid & water based liquid aerosols
- Protection against inhalation of dangerous particulates
- Constructed from polypropylene and polyester synthetic material preventing allergies
- Aluminium nose bridge adjuster
- Lightweight and comfortable
- Exhalation valve reduces hot air build-up & provides easy breathing in hot & humid environments (QSA 2021 only)

- NRCS Homologated

Suitable Use:

- Household maintenance
- Mining
- Asbestos removal
- Agriculture
- Construction
- General material handling



1020 - FFP2 (NRCS AZ2004/18)

Complies with BS EN 149:2001 + A1:2009 FFP2 NR D
Dolomite tested as per BSI, CE 725172.



1021 - FFP2 VALVED (NRCS AZ2004/17)

Complies with BS EN 149:2001 + A1:2009 FFP2 NR D
Dolomite tested as per BSI, CE 725172



1231 - FFP3 VALVED (NRCS AZ2004/15)

Complies with BS EN 149:2001 + A1:2009 FFP3 NR D
Dolomite tested as per BSI, CE 725172



1121C VALVED - FFP2

(NRCS AZ2004/24)
Complies with BS EN 149:2001
+ A1:2009 FFP2 OR NR D
Dolomite tested as per BSI, CE 690046



1131 VALVED - FFP3

(NRCS AZ2004/14)
Complies with BS EN 149:2001
+ A1:2009 FFP2 OR NR D
Dolomite tested as per BSI, CE 690046

DRO-AIR 1000 SERIES

- Low breathing resistance for increased wearer comfort
- Heavy duty, tab mounted head straps (1231 only)
- Aluminium nose bridge adjuster
- Soft foam nosepiece for comfort & custom fit
- Contour face seal for performance & comfort
- Constructed from polypropylene and polyester synthetic material preventing allergies
- Exhalation valve reduces hot air build-up & provides easy breathing in hot & humid environments

ACTIVE CARBON RESPIRATORS

- Active Carbon Pre-Filter for organic vapours & welding fumes
- Low breathing resistance for increased wearer comfort
- Heavy duty, tab mounted, head straps
- An external aluminium adjustable nose clip
- Constructed from polypropylene and polyester synthetic material preventing allergies
- Soft foam nosepiece for comfort & custom fit
- Contour face seal for performance & comfort
- Exhalation valve reduces hot air build-up & provides easy breathing in hot & humid environments

N95 DISPOSABLE RESPIRATORS



- Suitable for a single 8-hour use against solid & water based liquid aerosols, that do not contain oil
- Protection against inhalation of dangerous particulates in high dust areas
- Meets CDC guidelines for M. Tuberculosis exposure control
- Can be used as part of a disease control strategy
- An ergonomic design that provides a comfortable and secure fit for different facial sizes
- A welded elastic strap along with the half face seal foam reinforces the seal with the lowest leakage.
- Lightweight with low breathing resistance for increased wearer comfort
- N95-5151 & N95-6151 includes an exhalation valve, which reduces hot air build-up & provides easy breathing in hot & humid environments
- Conforms to 42 CFR part 84, N95 class, NIOSH approved, TC-84A-448 (6151), TC-84A-7220 (5151) TC84A-7719 (5150)

Suitable Use:

- Agriculture
- Construction
- General material handling
- Medical industry applications



CODE: N95-6151



CODE: N95-5151 (VALVED)



CODE: N95-5150 (UNVALVED)

3000 SERIES

3231- FFP3 VALVED (NRCS/8072/0169)

Complies with BS EN 149:2001 + A1:2009 FFP3 NR D

Dolomite tested as per BSI, CE 690046

- Suitable for a single 8-hour use against solid & liquid based aerosols in high dust areas
- Low breathing resistance for increased wearer comfort
- Adjustable head straps
- Plastic adjustable nose clip
- Contour face seal for performance & comfort
- Soft foam nosepiece for a custom fit
- Exhalation valve reduces hot air build-up & provides easy breathing in hot & humid environments
- Dolomite tested for resistance to clogging

Suitable Use:

- Mining
- Asbestos
- Agriculture
- Construction
- General material handling industries

3 PLY MASK

CODE: DR-F103

- Suitable for a single use
- Spun bonded polypropylene non-woven fabric with filter
- Protection against incidence of cross infection of airborne infective bacterial agents - 95% filtering efficiency
- 100% Latex free ear band loop
- Hypoallergenic
- Can be used as part of a disease control strategy
- 3-Pleat triple layer construction provides stronger support
- Adjustable aluminium nose bar
- Low breathing resistance for increased comfort

Suitable Use:

- Medical
- Dental
- Food preparation
- Clean or sensitive environments





Dromex

BREATHE EASY

CHOOSING RESPIRATORY PROTECTION

PARTICULATE, GAS AND VAPOUR FILTER SELECTION:

Filter Type	For use against	Colour Code	Other Information
A	Organic gases and vapours, boiling point > 65°C	Brown	EN 14387
B	Inorganic gases and vapours	Grey	EN 14387
E	SO ₂ and other acid gases	Yellow	EN 14387
K	Ammonia and its organic derivatives	Green	EN 14387
Hg	Mercury	Red and White	EN 14387, includes P3 particle filter Maximum use time 50 hours No class number
NO	Oxides of Nitrogen	Blue and White	EN 14387, includes P3 particle filter Single use only. No class number
AX	Organic gases and vapours, boiling point < 65°C	Brown	EN 14387 Single use only. No class number
SX	Substance as specified by the manufacturer	Violet	EN 14387
P	Particles	White	EN 143 EN 14387
CO*	Carbon Monoxide	Black	DIN 58620 EN 14387

- Change filters as instructed by the manufacturer, e.g. 'single use only' • Do not use if the expiry date on the filters has passed
- Change filters when damaged or visibly contaminated • Change before the contaminant can be smelled or tasted
- Change before the filter life indicated in your risk assessment
- For replaceable filters, it would be good practice to mark the filter visibly with the date it was taken out of the packaging and fitted to the RPE; an in-house replacement date can be added to this marking.

ACCESSORIES

These bags are designed to protect your reusable respiratory Midi-Mask or Full Face Mask & filters while not in use.

They also include a waist strap with quick release buckle so your equipment can be kept on you during the course of your work.



MIDI MASK BAG
CODE: DHRB-BLK



FULL FACE MASK BAG
CODE: DH-FFMBAG



SINGLE HALF MASK

CODE: DH-101

- Soft PVC mask with deep face mould for a comfortable fit with an excellent seal
- Dual wide elastic headband connected with a pin swivel connector, adjustable & with a quick release toggle
- Efficient exhalation valve
- For use with the DHCS single unifit filter cartridge system



PVC TWIN HALF MASK

CODE: DH-102

- Soft PVC mask with deep face mould for a comfortable fit with an excellent seal
- Dual wide elastic headband connected with a pin swivel connector, adjustable & with a quick release toggle
- Efficient exhalation mask
- For use with the DHCT twin unifit filter cartridge system



TPR TWIN HALF MASK

CODE: DH-202

- Soft TPR (Thermo Plastic Rubber) with a deep face mould for a comfortable fit with an excellent seal
- Dual wide elastic headband with a skull cradle and a pin swivel connector, adjustable & with a quick release toggle
- Efficient exhalation valve
- For use with the DHCT twin unifit filter cartridge system



FULL FACE MASK

CODE: DH-FFM

- Premium protection against hazardous vapours, gases & particulates
- Thermo Plastic Rubber full face seal
- Anti-fog visor with 220° vision
- 5-Point comfort harness with 2 grip holes ensures easier fitting
- Lightweight dual filter cartridge system evenly distributes weight of the mask during use
- Compatible with Dromex unifit twin filters
- Designed to withstand temperatures up to 70 °C
- One size fits all
- For use with the DHCT twin unifit filter cartridge system

These gas, vapour & dust filters are designed to fit the DroAir range of Midi & Full Masks. The full gas & particulate filter range is colour coded to European standards as per EN 141, EN 143 & EN 14387.

All Unifit filters are individually sealed and supplied with a replacement inhalation valve.

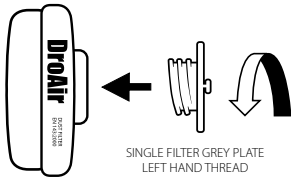

Single Filter Fitment
WARNING! Single filters should only be used with single masks.

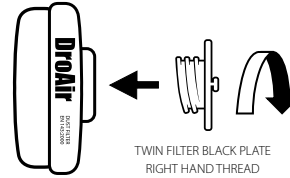

Twin Filter Fitment
WARNING! Twin filters should only be used with twin masks.

SINGLE FILTERS



DHCS A1 - Organic



DHCS P2 - Particle



DHCS / DHCT P2PF Pre-filter

**Available for single & twin cartridge respirators*

Suitably used with Dromex® gas cartridges that fit onto the Dromex cartridge respirators filtering out solids, dust and liquid aerosol hazards, which cannot be filtered by chemical cartridges.

Pre-filters prolongs the life of the corresponding gas filter.

TWIN FILTERS



DHCT A1 - Organic



DHCT A2 - Organic



DHCT B1 - Inorganic



DHCT-ABEK 1

- Organic, Inorganic,
 Acid & Ammonia



DHCT P2 - Particle



DHCT P3 - Particle



DHCT P3PF - Pre-filter



Dromex

HEARING PROTECTION

LISTEN UP





KNOW HEARING PROTECTION



Dromex

STEPS TO SELECTION & USE

The selection of hearing protection has a basic four-step method:

-  **Identify:** Measure and record the potential noise hazard.
-  **Assess:** The hazards and associated health risks should be assessed as well as other required protective equipment to ensure compatibility.
-  **Select:** The proper hearing protection suitable for the hazard should be selected. This is made easy using the EN 352 noise reduction ratings.
-  **Training:** Training is a very important step to optimise hearing protection by ensuring the operator is proficient in the use and limitations of his/her hearing protector.

HEARING LOSS

Hearing loss caused by exposure to noise at work continues to be a significant occupational illness despite the improvements made for comfort and attenuation. Hearing protection can play a vital part in avoiding occupational hearing loss. Although conformity to local legislation should always be a priority, cost effective solutions that are comfortable and easy to use also play a role.

Hearing loss can be gradual because of exposure to noise over time, but damage can also be caused by sudden & extremely loud noises. The damage is disabling as it can stop people being able to understand speech, keep up with conversations or it may develop into Tinnitus (ringing, whistling, buzzing or humming in the ears), a distressing condition which can lead to disturbed sleep.

EXPOSURE & PROTECTION

As a rule of thumb, if you must shout to be understood over the background noise when standing about 1 meter away from somebody, that background noise is hazardous.

Using EN352 hearing protectors, following safety requirements and testing the occupational risks assists with prevention of occupational noise-induced hearing loss.

- Protection is required if the environmental noise is over 85dB
- Noise below 75dB is considered to be non-hazardous

HEARING PROTECTION SELECTION GUIDE:

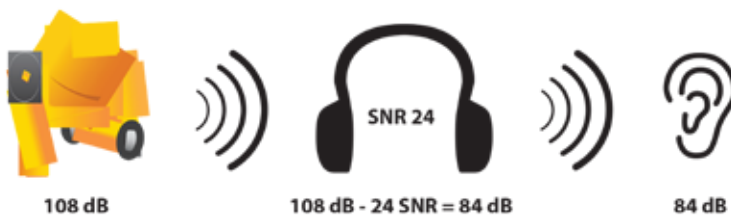

Dromex ear plugs & ear muffs are suitable for use in the following applications:

Machining & grinding, woodwork, steel cutting, aviation, high pressure steaming, shooting range, hunting, tree felling & forestry.

TYPICAL NOISE MEASUREMENTS

HARMFUL RANGE	180	Rocket launching	
	170	Rifle shot (1m) Shotgun	
	160	Immediate physical damage	
	150	Balloon popping Aircraft engine (30m)	
	140	Maximum allowable exposure Riveting hammer Air raid siren	
	130	Immediate pain threshold Vuvuzela Punch press	
	120	Chainsaw	
	115	Unprotected not allowed Nail gun Blasting Foundry rumble	
	110	Jack hammer	
	RISK AREA	100	Machine shop Grinding and cutting wheel Blast chiller Pig house when feeding Sandblasting Crushing mill Drilling concrete
90		Industrial fire alarm	
85		Hearing protection required Hair dryer Hand saw	
80		Vacuum cleaner	
SAFE AREA		75	Non-hazardous
		70	Inside a car
		60	Normal conversation
	50	Comfortable sound	
	40	Refrigerator	
30	Whisper		
20	Audible sound		
10	Normal breathing		
0	Zero		



EAR PLUG DISPENSER

CODE: DRO30-DISP



- Disposable ear plug dispenser that can be placed on a surface or wall-mounted
- Makes hearing protection easily accessible to staff & visitors
- Holds 500 pairs of DRO30 disposable foam ear plugs
- Refill packets sold separately (Code: DR030)

COMPOSITION:

- CE EN 352-2 (H=36 dB, M=35 dB, L=34 dB)
- SNR 37 dB

DISPOSABLE FOAM EAR PLUGS CORDED & UNCORDED



CODE: DR-098C



CODE: DR-098



CODE: DR-099C

- Disposable, hi-visibility fluorescent PU foam ear plugs
- PU coated for hygiene
- Smooth, soft, pliable & easy to use
- Superb attenuation
- Expands to fit ear canal comfortably increasing overall protection

DR-098C & DR-098 (Corded & un-corded)

- CE EN 352-2 (H=36 dB, M=34 dB, L=33 dB)
- SNR 37 dB

DR-099C (Corded)

- CE EN 352-2 (H=33 dB, M=33 dB, L=32 dB)
- SNR 35 dB

RE-USABLE EAR PLUGS



CODE: EG3301B



CODE: DR-090CDET



CODE: DR-118C



CODE: DR-090C



CODE: DR-090CI

- Hi-visibility blue triple flange TPR ear plugs
- H=28 dB, M=25 dB, L=25 dB)
- SNR 28 dB

- Hi-visibility fluorescent blue triple flange TPR ear plugs with detectable bearing
- H=33 dB, M=30 dB, L=28 dB
- SNR 32 dB

- Hi-visibility fluorescent blue triple flange TPR ear plugs
- H=31 dB, M=28 dB, L=27 dB
- SNR 31 dB

- DR-090C & DR-090CI** (Corded & Plastic Box)
- Hi-visibility fluorescent green triple flange TPR ear plugs
 - (H=33 dB, M=30 dB, L=28 dB)
 - SNR 32 dB

CLASSIC EAR MUFF

CODE: CEM

- Padded headband ear muff with soft foam cushions
- Low risk of entanglement on machinery
- Hearing protection for extended periods
- Durable self adjusting ABS cups
- Close fitting wire headband
- H=33,9 dB, M=26,4 dB, L=17,7 dB
- SNR 28,6 dB



JM EAR MUFF

CODE: JM-B



- Banded ear muff with soft foam cushions
- Adjustable rotational ABS cups
- Lightweight & robust design
- Suitable for light industrial duty & outdoor construction
- H=28 dB, M=23 dB, L=15 dB
- SNR 25 dB



BUSHMASTER

CODE: BUSH-WG / BUSH-PC

- Twin point mounted, adjustable ABS cups and soft foam cushions
- Hearing protection for extended periods
- Visor can easily flip up and down
- Close fitting wire headband for comfort
- H=36 dB, M=27 dB, L=18 dB
- SNR 30 dB
- Replacement visors sold separately:
Gause: BUSH-BWGVISOR
Polycarbonate: BUSH-BPCVISOR



INTEREX

CODE: INTEREX



- EU slotted
- Unique DROMEX connector that fits all hard hats
- Large twin point mounted cups with soft foam cushions
- Easy to attach & detach with spring loaded arms
- Steel arms maintain a constant & even pressure
- Adjustable cup for optimum comfort & fit
- H=31 dB, M=26 dB, L=19 dB
- SNR 28 dB





SAFETY EYEWEAR



Dromex



ORDER OF MARKING ON OCULARS WHERE RELEVANT:

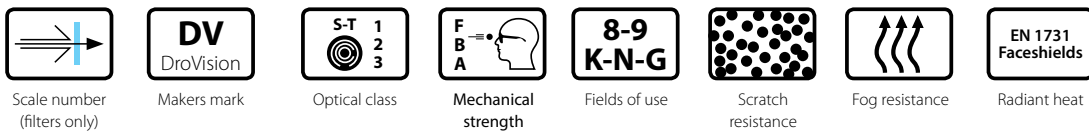

ORDER OF MARKING ON FRAMES WHERE RELEVANT:

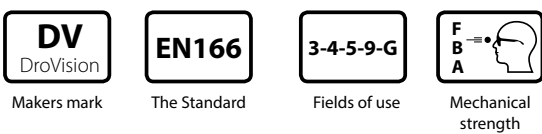

LENS SELECTION AND APPLICATION:

Clear		general indoor use eye protection against impact hazards	
Grey		sunglare 5-2,5	Outdoor anti-glare lens use to prevent eye fatigue from sun glare
Amber		uv 2-1,2	Prevention of high density light (hdl) for contrast and rotational clarity
Green		sunglare 5-2,0	Prevent eye fatigue from indirect light flash
IR green		infrared 4-IR3 or 5	Used for certain welding & gas cutting techniques
Mirror		sunglare 5-1,7	Indoor/outdoor (i/o) for artificial and sunlight glare
Blue		sunglare 5-2,5	Outdoor anti-glare lens use to prevent eye fatigue from sun glare

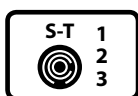

FIELD OF VISION (OPTICAL CLASS)

1 - $\pm 0,06$ DIOPTRES
 2 - $\pm 0,12$ DIOPTRES
 3 - $\pm 0,25$ DIOPTRES

Optical class 1, 2 or 3 - indicates optical quality of the ocular and the wear duration

OCULAR (1 - 3)

PERMANENT WEAR
 OCCASIONAL WEAR
 EXCEPTIONAL WEAR

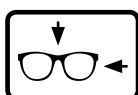

ROBUSTNESS

FRAME AND OCULAR are required to withstand specified lateral and frontal impacts at specified speeds

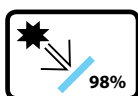

AGEING

FRAME AND OCULAR stability at elevated temperatures and ultraviolet radiation (oculars only)

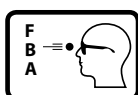

HIGH SPEED PARTICLES

F – LOW ENERGY
 B – MEDIUM ENERGY
 A – HIGH ENERGY
 S – INCREASED ROBUSTNESS

OCULAR (6mm STEEL BALL (0 86g))









45 m/s
 120 m/s
 190 m/s
 (See optional below)



X	X	X
	X	
		X
X	X	X

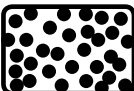
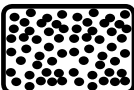

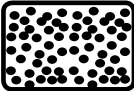
OTHER FIELDS OF USE:

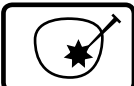
				
	3 – LIQUIDS Liquid droplets for goggles Liquid splash for face shields but not mesh		X	X
	4 – LARGE (COARSE) DUST PARTICLES for goggles		X	
	5 – GAS & FINE DUST PARTICLES		X	
	8 – SHORT CIRCUIT ELECTRIC ARC Face-shield to comply with a filter of scale number 2-1,2 or 3-1,2 and have a minimum thickness of 1,4 mm			X
	9 – MOLTEN METAL & HOT SOLIDS Both the frame and ocular shall be marked with this symbol together with one of the symbols F, B or A		X	X
	K – GAS & FINE PARTICLE DAMAGE			X
	N – RESISTANCE TO FOGGING (8 seconds)	X	X	X
	G – RADIANT HEAT (EN 1731)		X	
	S – INCREASED ROBUSTNESS (22mm ball at 5, 1 m/s)	X	X	X
	T – EXTREME TEMPERATURE (-5 to 55°C) Used in conjunction with either F, B or A to indicate that the eye protector conforms to the high-speed particle classification at extremes of temperature	X	X	X
	ANTI-SCRATCH Optional anti-scratch coating to protect the eye protector			



Available frame colours:

- CODE: DV-353C-AFL
- CODE: DV-353C-AFB
- CODE: DV-353C-AFR

- Polycarbonate mono lens, multi colour frame & rubber temples
- Scratch resistant & Anti-fog lens
- **Suitable Use:** Construction, mining, instrument installations & warehousing

SPORTY COOL

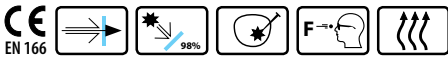

Available frame colours:

- CODE: DV-894G-AF-R
- CODE: DV-894G-AF-B
- CODE: DV-894G-AF-Y

- Polycarbonate mono lens, multi colour frame & rubber temples
- Scratch resistant & anti-fog lens
- **Suitable Use:** Outdoor use for glare, forklift drivers, & construction

FOCUS



CODE: DV-098C-AF

- Polycarbonate mono lens, multi-coloured nylon frame & temples
- Scratch resistant & anti-fog lens
- Soft nose seat for comfort
- **Suitable Use:** Construction, instrument installations, general industry

SPORTY RACER



Available lens colours:

- CODE: DV-55G-AF
- CODE: DV-55C-AF

- Polycarbonate dual lens, black nylon frame & adjustable temples
- Soft nose seat for comfort
- Scratch resistant & anti-fog lens
- Grey: Anti-glare lens
- **Suitable Use:** General industry & safety officers.

Grey - Outdoor & construction environment

CLASSICS



SPORTY



Available lens colours:

- CODE: DV-12C / AF
- CODE: DV-12G
- CODE: DV-12A-AF
- CODE: DV-12GN
- CODE: DV-12M (Mirror)

- Polycarbonate frame & mono lens, wide black frame & vinyl temples
- Scratch resistant lens
- *Clear & Amber*: Anti-fog lens
- *Mirror, Green & Grey*: Anti-glare lens
- **Suitable Use:** Construction, mining, milling, engineering workshops, factories, general industries, warehousing

EURO



Available lens colours:

- CODE: DV-026-C / DV-026-C-AF
- CODE: DV-026-G
- CODE: DV-026-A
- CODE: DV-026-GN

- Polycarbonate mono lens, black nylon frame & adjustable temples
- Scratch resistant lens
- Anti-fog lens (clear only)
- Anti-glare lens (amber, grey & green)
- **Suitable Use:** Construction, mining, milling, engineering workshops, factories

WELDING



IR5



IR3



CODE: DV-026-IR3 / IR5

- Polycarbonate mono lens, black nylon frame & adjustable temples
- Scratch resistant lens
- **Suitable Use:** Welding industry

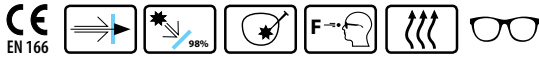

Available lens colours:

- CODE: DV-326B-C-AF
- CODE: DV-326B-G-AF

- **Used as a spectacle or a goggle all in one!**
- Prescription lens inner attachment
- Polycarbonate mono lens & soft rubber face seal
- Efficient indirect ventilation system
- Detachable black polycarbonate adjustable temple
- Detachable 12mm adjustable elasticated headband
- Anti-fog & scratch resistant lens
- **Suitable Use:** General industry, light chemical splashes

SPOGGLE

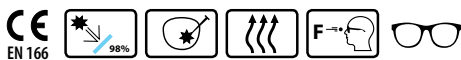

CODE: DV-004MAX

- Clear (EN 170 2-1,2) polycarbonate mono lens
- 25mm Elasticated & adjustable headband
- High quality PVC frame
- Wide face contact area for comfort & seal
- Efficient indirect ventilation system
- Suitable with prescription spectacles
- Anti-fog lens & scratch resistant lens
- **Suitable Use:** Grinding, woodwork, light chemical splashes

MAXI VIEW GOGGLES



CODE: DV-GW5

- Shade 5, flip-up, polycarbonate mono lens
- Soft rubber face seal
- Efficient indirect ventilation system
- 11mm Adjustable elasticated headband
- Scratch resistant lens & anti-mist lens
- **Suitable Use:** Welding industry & applications



WELDING GOGGLE



WRAP AROUNDS



Available lens colours:

-  **CODE: DV-1C**
-  **CODE: DV-1A**
-  **CODE: DV-1GN**

- Polycarbonate mono lens & temples with ventilation
- Can be used with prescription spectacles as an over spectacle
- *Amber & Green:* Anti-glare lens
- Scratch resistant lens
- **Suitable Use:** Overspecs & visitors glasses

WIRE MESH



EN 1731

CODE: DV-504

- Metal wire mesh dual lens
- Clear polycarbonate & removable side protectors & vinyl adjustable temples
- **Suitable Use:** Forestry, woodwork, carpentry, mining

ACCESSORIES

- **BLACK POUCH BAG (CODE: F-POUCH)**
- **GREEN RETAINER CORD (CODE: 8A-G)**
- **BLACK RETAINER CORD (CODE: 2803-W)**





Dromex

CUT⁵



Dromex
CUT5



CAMO

CODE: 52J

EN 388

EN 407



4542

X1XXXX

- High cut & abrasion resistance
- High contact heat protection
- High dexterity
- Colour UV resistant
- Lint free & washable
- 100% Dromex Cut5 fibre
- Seamless ergonomic liner
- Ultra grip PU anti-slip coating
- Reinforced thumb crotch
- Composite knitted wrist

Suitable Use:

- Military & police, outdoor hunting, mining & extraction, search & recovery

Sizes: 8 - 11



SEAMLESS

CODE: 55M-Y

EN 388

EN 407



454X

X2XXXX

- High cut & abrasion resistance
- High contact heat protection
- Colour UV resistant
- Lint free & washable
- 100% Dromex Cut5 fibre
- Seamless ergonomic liner
- Reinforced crotch area
- Composite knitted wrist

Suitable Use:

- Automotive, glass & steel industries

Sizes: 7 - 10



LATEX COATED

CODE: 59YSP

EN 388



3X43D

- High cut & abrasion resistance
- High contact heat protection
- High cut resistance
- High grip power
- Colour UV resistant
- 100% Dromex Cut5 fibre
- Ultra grip crinkle Latex coating
- Seamless ergonomic liner
- Composite knitted wrist
- Lint free & washable

Suitable Use:

- Automotive, glass & steel industries

Sizes: 8 - 11



NITRILE COATED

CODE: #57

EN 388:2016

+ A1:2018



4X43C

- High cut & abrasion resistance
- High contact heat protection
- High grip power
- Colour UV resistant
- 100% Dromex Cut5 fibre
- Ultra grip Nitrile coating
- Composite knitted wrist
- Colour UV resistant
- Lint free & washable

Suitable Use:

- Automotive, glass industry steel industry, chemical handling, oil & gas

Sizes: 7 - 12

Dromex
CUT5



CODE: 57H201B



CODE: 57H201PLUS

CHEMICAL

EN 388

EN 407



4543

X2XXXX

- 100% Dromex Cut5 fibre
- HCT Nitrile multilayer technology
- Soft organic cotton inner liner
- H201B has extended cuffs
- H201PLUS 35cm cut resistant liquid chemical glove
- High cut & abrasion resistance
- General chemical resistance
- High contact heat resistance
- Colour UV resistant
- Lint free & washable

Suitable Use:

- Automotive industry
- Glass industry
- Steel industry
- Chemical handling
- Oil & gas
- Recycling & waste environments
- Mining extraction

Sizes: 10 (H201B)
8 to 10 (H201PLUS)

MECHANICAL

NEW

CODE: HFM305

EN 388:2003

EN 388:2016



OEKO-TEX®
STANDARD 100



4543

4X43C

CUT

- HCT Nitrile multilayer coating on palms & fingers
- Excellent grip & resistance to oil
- Reinforced thumb crotch
- High cut & abrasion resistance
- High dexterity
- High tear & puncture resistance
- Compliant with OEKO-TEX® standard 100

Suitable Use:

- Automotive industry
- Glass industry
- Steel industry
- Mining
- Oil & gas environments
- Construction
- Mild chemical handling

Sizes: 6 - 11





CODE: 50-60THV
(60cm)



CODE: 50-135-TY
(35cm)

FOOD SERIES

CODE: 55LF



- 100% Dromex Cut5 fibre
- FDA & German food grade approved
- Seamless with a composite knitted wrist
- Ambidextrous
- High cut & abrasion resistance
- Contact heat protection
- Colour UV resistance
- Sanitised treatment
- Extra length
- Lint free & washable

Suitable Use:

- Food processing, boning & carving, fish filleting, meal preparation, food handling

Sizes: 7 - 11

(*Note these gloves are sold as individual units)

SLEEVES

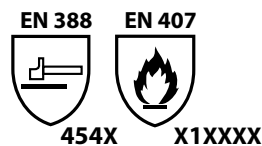

- 100% Dromex Cut5 Fibre sleeve with thumb hole
- High cut & abrasion resistance
- High contact heat protection
- Colour UV resistant
- Lint free & washable

Sizes:

- One size fits all

Suitable Use:

- Automotive industry
- Glass industry
- Steel industry
- Machining & welding
- Construction industry
- Mining & extraction industry

(Note these items are sold as individual units)

Dromex
CUT5



IMPACT

CODE: 52LSTPV

EN 388



4442CP

- 100% Cut5 fibre
- Innovative TPV impact protection
- PU dipped palm
- Seamless ergonomic liner
- Velcro closing for enhanced fit
- Composite knitted wrist
- High abrasion & puncture resistance
- High cut & tear resistance
- High impact protection
- TPV impact protection
- Enhanced dexterity & flexibility
- Good grip

Suitable Use:

- Oil & gas industry
- Industrial handling & packaging
- Automotive industry
- Construction & landscaping
- Assembly industry & plants
- Heavy machinery equipment operations

Sizes: 8 to 10



MACH 777

CODE: MACH-777

EN 388



4444CP

- Cut5 HDPE lining
- High impact, abrasion, cut & tear resistance
- Black Nitrigrip & vibro-impact reinforced palm
- Grey back with black/lime IMPACT knuckle guard
- 7cm waterproof neoprene cuff with reflective tape
- Hi-Viz TPR on back of fingers & thumb
- Foamed padding on palm for anti-vibration
- Multifunctional mechanical glove

Suitable Use:

- Heavy machinery
- Mining
- Automotive
- Packaging & warehousing

Sizes: 7 - 13



Dromex
CUT5



MACH30WP

CODE: MACH-30WP

EN 388:2016

+ A1:2018



4442CP

- Hi-Viz Cut5 Mechanical glove
- Multi function
- Impact resistant
- Anti-vibration
- Checker palm for grip
- Waterproof
- Latex foam reinforced multi-colour
- TPR back of hand impact protection

Suitable Use:

- Heavy machinery
- Mining industry
- Oil & gas industry
- Automotive/aerospace
- Packaging/assembling
- Drilling

Sizes: 8 - 11



MACH MECHANIC

CODE: MACH100WP

EN 388



4542

- Hi-Viz Cut5 Mechanical glove
- Waterproof
- Impact resistant
- Anti-vibration
- Oil repellent fabric
- Kevlar fabric patch & anti-vibration patch on palm
- Latex foam reinforced multi-colour
- TPR back of hand impact protection

Suitable Use:

- Heavy machinery
- Mining industry
- Oil & gas industry
- Automotive/aerospace

Sizes: 8 - 11



1100001001
MIZU 300MM
SIZE 10



SPECIALISED GLOVES



Dromex

TECHNOLOGY

UNDERSTANDING THE NEW GLOVE STANDARD

You may have heard about the new glove standard but not quite sure what it means or how it's going to affect you.

Let's unpack what's changed by comparing the old to the new, explain the new testing methods and show you what to expect from the new glove markings.

OLD vs NEW

The new EN 388:2016 standard released in November 2016 has replaced the old EN 388:2003 glove standard in Europe.

Testing on resistance to abrasion, tear and puncture are carried out as they were before with minor clarifications to testing procedures and materials. The test results correspond the same way they did in the 2003 version with ratings of 0-4, with 4 being the highest performance level.

The main difference in the 2016 edition is in relation to cut resistance and impact protection. The new version now includes a TDM blade test in addition to the existing Coup Method and a test for impact resistance.

Existing Cut Test - Coup Method:

Under the EN 388 glove standard, introduced in 2003, cut resistance is measured with a Coup Test machine. A section of fabric is placed in a holder and a rotating circular blade is moved back and forth at a constant speed, pressing down with a force of 5 Newtons. When the blade cuts through, a performance rating from 1 to 5 is calculated from the total distance of travel. The blade gradually loses sharpness, so at the start and finish it is calibrated using cotton fabric. Therefore, the result can be less accurate for gloves with a higher cut-resistance. This test method remains in the 2016 version but is only to be used for materials that do not affect the sharpness of the blade.

Additional New Cut Test - TDM blade test:

TDM is an abbreviation for the equipment used to conduct this test, a tomodynamometer. This test involves a straight blade being drawn across the sample in one movement, with a new blade every time. The 'stroke length' before cut-through is recorded for a range of forces and graphs plotted to predict the force required to cut through the glove in 20mm of travel. This force is used to calculate a score from A to F, with F being the highest rating.

Impact Testing

Impact verification has been added to EN 388: 2016. The test method is taken from the motor cycle standard EN 13594:2015.

The area where the impact protection is claimed to be tested, but due to technical reasons, the area around the fingers cannot be tested.

If the requirements are fulfilled, the glove will be marked with a P (Pass). If the glove fails, there will be no marking.

HOW DOES THIS AFFECT YOUR CURRENT GLOVES?

EN 388:2016 supersedes EN 388:2003 BUT it only affects new product certification and will not apply retrospectively.

Gloves may continue to be sold under both versions of the standard until 2023 when, under the new PPE regulation, certification will need to be renewed to the latest version of the standard.

GLOVE MARKINGS

EN388:2003

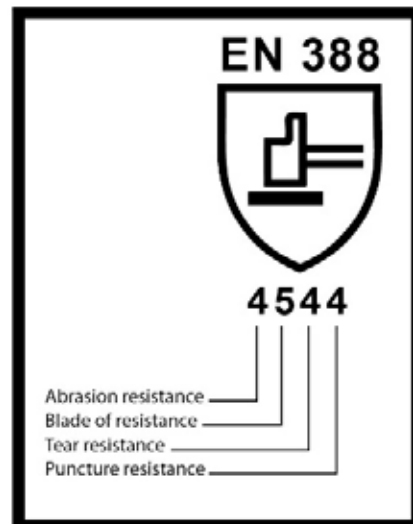

EN388:2016

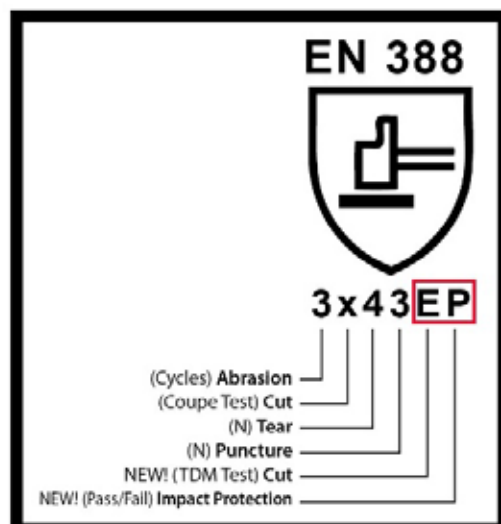

Know Safety. No Injury. Know Dromex.



INFERNO

CODE: INFERNO

- Tan leather multi-layered fire fighters glove
- High breathability
- High heat resistance
- High temperature stability
- High abrasion resistance
- PU moisture barrier
- Multi-layer protection provides flexibility, comfort & excellent insulation

Sizes: M - XL

Meets with the requirements of NFPA 1971:2013 Edition: Standard on Protective Ensembles for Structural Fire Fighting.

- Gunn cut wing thumb with reinforced index & middle finger palm
- Knitted cuff with continuous pull & shirred back
- Multi-layer: hand layer is knitted composite modacrylic para-aramid fibre with a non-woven urethane vapor barrier. Finger tacked.
- Tan split cow leather palm 1.0 to 1.2mm with equivalent reinforcing
- Tan split cow leather back 1.0 to 1.2mm, shirred
- Yellow aramid knitted wrist cuff with tan split cow leather 0.8 to 1.0mm leather continuous pull

Suitable Use:

- Structural & wildland fire fighting applications
- Search & rescue



IRON MAN

CODE: S-H33

EN 388



3544X

EN 407



444344

- Kevlar palm & aluminium back with Kevlar lining
- High heat resistant with contact heat up to 500°C
- Protection against molten metal sparks & splash
- 100% Cotton with PU foam cotton liner
- Excellent resistance to abrasion, cut & tear
- Excellent grip
- 360g per glove

Sizes: 10

Suitable Use:

- Foundry
- Forging
- Welding
- Furnaces



MOLTEN WARRIOR

CODE: S-H35

EN 388



3444X

EN 407



444344

- Leather palm & aluminium back with Kevlar lining
- High heat resistant with contact heat up to 500°C
- Protection against molten metal sparks & splash
- 100% Cotton with PU foam cotton liner
- High resistance to abrasion, cut & tear
- Excellent grip in oily conditions
- 398g per glove

Sizes: 10

Suitable Use:

- Foundry
- Forging
- Welding
- Furnaces

ULTI-CHEM

CODE: ULTICHEM

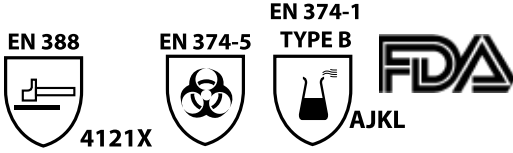

- Triple coated, lightweight nitrile glove with micro foam palm
- Protection against chemicals, mechanical & micro-organism risks
- Excellent dexterity & grip
- FDA (Food & Drug Administration) accredited
- Resistant to:
 - A: Methanol
 - J: n-Heptane
 - K: Sodium Hydroxide 40%
 - L: Sulphuric Acid 96%

Sizes: 8 - 10

Suitable Use:

- Chemical handling as per EN 374
- Cleaning industry
- Janitorial industry
- Environmental clean-up



ULTI-CHEM^{PLUS}

CODE: ULTICHEMPLUS

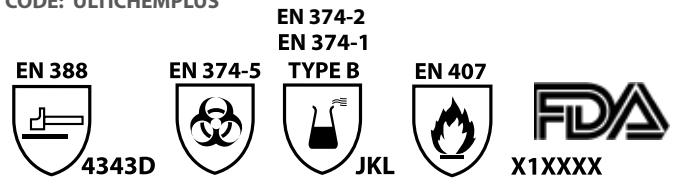

- Premium protection against chemicals, mechanical, contact heat & micro-organism hazards
- High cut performance Polyethylene, glass fibre, spandex
- Triple coated, lightweight nitrile glove with a micro foam finish
- Excellent dexterity & grip
- FDA (Food & Drug Administration) accredited
- Resistant to:
 - J: n-Heptane
 - K: Sodium Hydroxide 40%
 - L: Sulphuric Acid 96%

Sizes: 8 - 10

Suitable Use:

- Chemical handling as per EN 374
- Laboratories
- Sheet metal handling
- Assembly work & automotive



VIPER & VIPER^{PLUS}

CODE: VIPER / VIPERPLUS

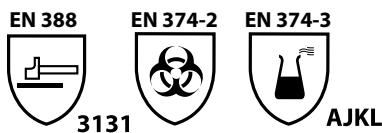

- Viper: 35cm length | Viper Plus: 60cm length
- Protection against chemicals, mechanical risks & micro-organisms
- Double dipped PVC
- Textured palm for grip in wet & oily conditions
- Comfortable cotton liner
- High abrasion protection & tear resistance
- Impermeable protection
- Resistant to:
 - A: Methanol
 - J: n-Heptane
 - K: Sodium Hydroxide 40%
 - L: Sulphuric Acid 96%

Sizes: 9 - 10

Suitable Use:

- Chemical handling as per EN 374
- Petrochemical
- Assembly & metal fabrication
- Waste water & water treatment

CHEMICAL NITRILE

CODE: 0056



- Green Nitrile unsupported (0.38mm) thick, 33cm length
- Micro flock lined for comfort
- Straight cuff with textured palm, fingers and partially on the wrist for grip
- Washable
- Resistant to
 - K: Sodium Hydroxide 40%
 - L: Sulphuric Acid 96%
 - J: n-Heptane

Sizes: 6 - 10

Suitable Use:

- Chemical handling as per EN 374
- Chemical processing
- Oil refining petrochemicals
- Mild acids & Solvents
- Oils & greases
- Food processing
- Automotive assembly
- Painting & maintenance



OIL-TECH

CODE: DG-OIL-TECH

EN 388



4121X

- Double dipped & fully coated nitrile glove
- Protection against mechanical risks
- Superior dexterity
- Textured palm for grip in wet & oily conditions
- 13-Gauge comfortable seamless nylon liner
- High abrasion protection & tear resistance
- Provides liquid protection & water resistant

Suitable Use:

- Oil & gas industry (OGP)
- Mining & extraction
- Heavy machinery
- Aerospace
- Mechanical workshops
- Automotive
- Precision engineering applications

Sizes: 8 - 11

THOR ELECTRICAL INSULATING GLOVES

CODE: DG-THOR

AC (alternating current)
RC category PN-EN 60903:2006
(EN 60903:2003 + AC2:2005)

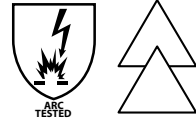

- Exclusively for electrical purposes
- R - acid resistant, oil resistant, ozone-resistant
- C - resistant to extremely low temperatures
- High quality rubber latex
- High flexibility preventing hand fatigue
- Fits well when worn with protective leather over gloves
- Each glove is electrically tested & issued with an examination certificate
- 360mm (±15mm) long

Sizes:

- Class 0 - 2: 8 - 10
- Class 3: 9 & 10

Available in four classes defining voltage requirements:

- CLASS 0 > 0 (5kV), Low voltage
- CLASS 1 > 1 (10kV), High voltage
- CLASS 2 > 2 (20kV), High voltage
- CLASS 3 > 3 (30kV), High voltage

Suitable Use:

- Electrical purposes, installation, maintenance & repairs

LEATHER OVER GLOVES

CODE: DG-OV

EN 388:2016 + A1:2018

EN 407:2020

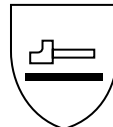

3132



4XXXXX

- Designed to protect the Thor electrical insulating gloves from potential hazards such as cut, abrasion, tear, puncture & flame.
- Can also be used as mechanical gloves, worn directly over the hands for non-electrical / arc applications
- Adjustable Velcro strap ensuring secure fit
- Waterproof cow grain leather with Kevlar thread
- High resistance to flammability
- Highly flexible & durable

Sizes: S / M
L / XL

Suitable Use:

- Electrical purposes, installation, maintenance & repairs
- Mechanical applications



NITRIFLEX

EN 388



4121

- High abrasion
- Strong oil-resistance
- Super grip
- Softer touch & higher flexibility
- 100% Nitrile micro foam finish
- Nylon blended spandex liner
- Innovative fibre
- Composite knitted wrist
- Sanitised



CODE: NITRIFLEX

Sizes: 7 - 11

Suitable Use:

- General maintenance (indoor & outdoor)
- Assembly work (indoor & outdoor)



CODE: NITRIFLEXPC



GNYLON

CODE: GNYLON

EN 388



- Ultra thin for comfort & tactile sensitivity
- Ambidextrous
- Eliminates fingerprints & scratches
- Reduces perspiration on palms
- Composite knitted wrist
- Dust & lint retardant
- Washable & reusable

Sizes: 8 - 10

Suitable Use:

- Automotive industry
- Glass & steel
- Chemical handling
- Oil & gas



NITROLITE

CODE: NITROLITE

EN 388



4131

- High abrasion
- Oil solvent resistance
- High dexterity
- Grey nitrile palm coated
- Nylon seamless shell
- Composite knitted wrist

Sizes: 7 - 10

Suitable Use:

- Engineering assembly
- Workshops
- General handling



CHAIN MAIL

CODE: RTCMG-01

DIN EN 1082-1

- Stainless steel chain mail glove
- Ambidextrous
- Wrist length
- Washable
- Tapered fit design
- 20mm Colour coded fastening wrist band
- Supplied with glove tensioner

Sizes: XS - XL (Colour of band differs per size)

Suitable Use:

- Bandsaw
- Straight edge cutting machine operation
- Abattoir
- Meat & poultry & butchery



CODE: MIIZU300HI



CODE: MIIZU300BLU

NEW

MIIZU 300

EN 388



4131X

- High visibility
- High durability
- High dexterity
- Super grip
- Waterbased PU & Nitrile micro foam finish
- Composite knitted wrist

Suitable Use:

- Automotive assembly
- Component assembly
- Packing assembly
- General handling

Sizes: 8 - 11



MIIZU 400 THERMAL

CODE: MIIZULFM4001W

EN 388:2016

+ A1:2018

EN 511:2006



2232X



X2X

- High visibility
- Soft yellow polyester glove with poly-acrylic fleece lined fibre
- Micro foam latex palm & fingers for excellent grip
- Good abrasion, puncture, tear & cut resistance
- Functions at temperatures up to -50 °C

Suitable Use:

- Cold storage
- Outdoor winter applications
- Fisheries
- Logistics

Sizes: 8 - 10



CODE: PU2001B



CODE: PU2001

PU20.01

EN 388



4131

- High durability
- High dexterity
- Super grip
- Protection against abrasion
- 100% Polyurethane palm & finger coating
- 100% Nylon seamless liner
- Composite knitted wrist

Suitable Use:

- Automotive & machining
- Component assembly
- Packing assembly

Sizes: 6 - 10 (PU2001B) • 6 - 11 (PU2001)

MACH IMPACT

CODE: MACH-2WP15

EN 388



3141

- Maximum dexterity & high grip performance
- Back of hand impact protection
- Provides optimum balance between flexibility & impact dispersion
- Waterproof

Suitable Use:

- Oil & gas industry
- Industrial handling & packaging
- Mining industry
- Automotive industry
- Construction & landscaping
- Assembly industries & plants
- Agriculture industry
- Heavy machinery equipment

Sizes: L



MACH MINERS

EN 388



3121

- Impact absorbing & 3 dimensional protection
- Thermo plastic rubber on back of fingers & thumb
- Anti-slip palm
- Highly reflective knuckle strip with an ergonomic design reducing hand fatigue
- Multi-functional protection

Suitable Use:

- Mechanics
- Strip miners
- Machine & equipment operators
- General warehousing

Sizes: 8 - 12 (MACH4)
8 - 11 (MACH6)



CODE: MACH-4



CODE: MACH-6
(WATERPROOF)

MACH DURA GRIP

CODE: MACH-5

EN 388



2121

- Multi-functional anti-vibration mechanical glove with finger, thumb, palm & back protection
- Maximum dexterity & non-slip performance
- Synthetic leather palm & durable anti-slip PVC patches
- Strengthened palm for gripping power in slippery conditions
- High visibility composite Poly/Spandex knitted fabric

- Optimum balance between anti-slip & protection for back of hand
- Double stitched black triangular indent pattern PVC palm, index & thumb patch
- Black form fitting leatherette palm & knuckle area
- Fluorescent yellow spandex back
- Velcro elasticated wrist strap

Suitable Use:

- Outdoor machinery
- Mining
- Automotive

Sizes: 9 - 10





PU5

CODE: PU5

EN 388



3442C

- High mechanical strength
- Cut level 5 (EN 388:2003)
- Cut level 4 & C (EN 388:2016)
- Superior dexterity & grip
- High tear resistance
- Protection against abrasion, cut & puncture hazards
- PU Coated palm & fingers
- HDPE Liner

Sizes: 7 - 10

Suitable Use:

- Automotive industry
- Component assembly
- Packaging
- Warehousing



SUPERLITE

CODE: PU20.02

EN 388



4131

- High durability
- High dexterity
- Super grip
- High sensitivity on the fingers area
- PU Coated palm & fingers
- Blue seamless light nylon liner
- Innovative fibre
- Composite knitted wrist

Sizes: 8 - 11

Suitable Use:

- General maintenance
- Assembly work
- Fine assembly work
- Small component handling



ANTI-STATIC

CODE: PU20.07E

EN 388



4131

- Anti-static
- High durability & dexterity
- Super grip
- High sensitivity on the fingers area
- PU Coated palm & fingers
- White seamless light nylon liner
- Innovative fibre
- Composite knitted wrist

Sizes: 7 - 10

Suitable Use:

- Assembly where static discharge has to be avoided
- Computer & circuit board work
- Automotive cluster work



DYTEC

CODE: DYTEC

EN 388



4342

- Cut level 3
- High durability & dexterity
- Super grip
- High sensitivity on the fingers area

- PU Coated palm & fingers
- 100% Dytec3 seamless light liner
- Innovative fibre
- Composite knitted wrist

Suitable Use:

- Coal mining
- Working with shale or sharp rocks

Sizes: 8 - 11



WORKING GLOVES



Dromex



CODE: DH100



CODE: GCOT/DD



CODE: GCOT



CODE: GCOT/W-L

COATED GLOVES



CODE: 1412A



CODE: GFREEZER/OC



CODE: NITRILE 0722



CODE: NITRILE 0742



CODE: NITRILE 0921



CODE: DH0911A



CODE: CRONUS/E



CODE: CRONUS/RGE



CODE: GCRAY



CODE: CRONUS/RGW



CODE: CRONUS/W



CODE: GPVC/27/HG



CODE: GPVC/40/HG



CODE: GPVC/27



CODE: GPVC/KW



CODE: GPVC/35



CODE: XTRA/27



CODE: XTRA/KW



CODE: XTRA/35



CODE: GCOM/KW



CODE: GLATEX/35

GLOVE ACCESSORY



CODE: GCLIP

RUBBER, LATEX & NITRILE GLOVES

NITRO SHIELD

CODE: DG-NITS

EN ISO 374-5:2016 EN 374-1 TYPE B



- 100% Nitrile which prevents allergies
- Disposable & powder free
- Lightweight yet strong due to the glove construction
- Comfortable and good dexterity
- Food safe and chemical resistant
- Beaded cuff for easy putting on & taking off in addition to offering drip protection for the forearm
- Biodegradable
- Ambidextrous
- FDA compliant

Sizes: S - XL

Suitable Use:

- Mild chemicals, bacteria, fungi, viruses & food products.



LATEX RUBBER GLOVES



CODE: H2-55



CODE: H1-40



CODE: H2-40

HOUSEHOLD GLOVES



CODE: DG-HS-B



CODE: DG-HS-Y



WELD PRIME

CODE: WELD/PRIME

EN 388 EN 407



4244 43314X

- Premium cow split leather
- Reinforced thumb
- Yellow cotton fleece hand lined and black cotton woven cuff lining.
- 16 inch cuff for full hand protection
- Contact heat resistance up to 350 °C for 15 seconds
- EN Approved

Sizes: 10

Suitable Use:

- Welding related operations



WELD RED

CODE: WELD/RED

- Premium grade cow split leather
- Fully cotton lined palm and fingers
- Gunn cut, apron palm & wing thumb
- Sewn with Kevlar thread

Sizes: 10

Suitable Use:

- Welding related operations

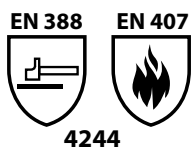

WELD BLUE

CODE: WELD/BLUE

- Premium A grade cow split leather
- A fully cotton lined palm and fingers
- Gunn cut fingers and winged thumb
- Reinforced leather palm, fingers, knuckle and pull strap
- Sewn with syntax thread

Sizes: 10

Suitable Use:

- Welding related operations



LEATHER / WELDING GLOVES



CODE: GGOAT-15CMC



CODE: WELD/6



CODE: WELD/2.5



CODE: GCANDY



CODE: GTIG/ECONO



CODE: GTIG



CODE: GGOAT



CODE: GRIGGER/EXEC



CODE: WELD/16GR



CODE: WELD/2.5GR



CODE: WELD/6GR



CODE: 88PBSA



CODE: G5



Dromex
ARC 60X120



Dromex

BODY PROTECTION



PROMAX DISPOSABLE COVERALL

CODE: PROMAX

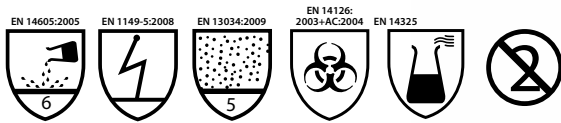

- Type 5 and 6 disposable coverall
- Microporous spun bound polypropylene and polyethylene laminate fabric with bound seams
- Zip and storm flap front closing
- Non-linting
- Good mechanical properties and performance
- Protects the arms, legs, torso and head from the hazards of light liquid sprays, chemical splashes and sprays, airborne solid particulates and anti-static dissipation
- Liquid penetration resistance against a basic range of chemicals:
 - Sulphuric Acid 30% - Class 3
 - Sodium Hydroxide 10% - Class 3
 - O-Xylene - Class 3
 - 1-Butanol - Class 3

Sizes: Small – 3XL

Suitable Use:

- Pharmaceutical
- Food processing
- Asbestos removal
- Accident attendance
- Fiber exposure
- Painting and spraying
- Clean rooms
- General maintenance





PROMAX 1000 DISPOSABLE COVERALL

CODE: PROMAX-1000

EN 14126:
2003+AC:2004



- A breathable microporous polyethylene with spunbond polypropylene composition that has excellent physical properties (strength, elasticity, tear etc)
- Enhanced waterproof performance providing impervious protection suitable for use against biological hazards
- All seams are taped for additional strength and protection especially against dangerous airborne particles & liquid
- Resistant to:
 - GB 19082-2009, clause 5.4 – Water penetration
 - GB 19082-2009, clause 5.4.3 – Penetration by synthetic blood
 - GB 19082-2009, clause 5.7 – Filtration efficiency
 - GB 19082-2009, clause 5.10 – Electrostatic decay properties

Sizes: M – XL

Suitable Use:

- Industrial & medical environments



PROMAX C4000 DISPOSABLE COVERALL

CODE: PROMAX-C4000

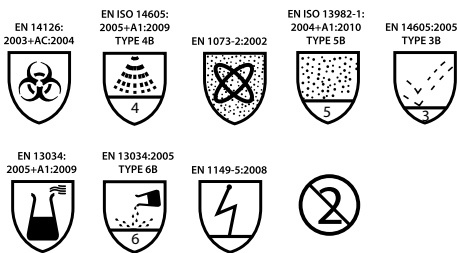

- Type 3, 4, 5 & 6 disposable coverall
- Yellow polypropylene and polyethylene foil fabric
- Ultrasonic welded & taped seams preventing permeation, dust & liquid ingress
- Double zip & storm flap for secure front protection
- Double elasticated cuff with thumb loop
- Double layer cushioned knee pads for comfort & durability
- Protects the arms, legs, torso & head from the hazards of light liquid sprays, chemical splashes & sprays, airborne solid particulates, radioactive contamination, anti-static dissipation & infective agents contact
- Resistant to penetration by blood/fluids, wet bacterial penetration, biologically contaminated aerosols & powders
- Permeation and chemical penetration protection against a basic range of chemicals:
 - Sulphuric Acid 96% - Class 6 (Permeation)
 - - Class 3 (Penetration)
 - Sodium Hydroxide 10% - Class 3 (Penetration)
 - o-Xylene - Class 3 (Permeation)
 - 1-Butanol - Class 3 (Penetration)

Sizes: S - 3XL

Suitable Use:

- Chemical handling & distribution
- Chemical clean ups
- Contaminated land cleaning
- Pathogens
- Oil spills
- Tank cleaning
- Petrochemical
- Refining applications





NON WOVEN DISPOSABLE COVERALL

CODE: PDISPO



- Disposable full body coverall for protection against dust & fine particulates
- 50gsm Spunbond polypropylene
- Elasticated wrists, legs & hood
- Nylon zipper front
- Lightweight

Sizes: M - 3XL

Suitable Use:

- General maintenance



**PROUDLY PRODUCED
IN SOUTH AFRICA**



WHATEVER THE WEATHER WE HAVE YOU COVERED.

Working outdoors or in cold environments means that the elements can sometimes be against you but one thing you can be sure of is that the Dromex Storm range is always on your side.

Dromex Storm apparel has been formulated for endurance in some of the harshest environments including cold storage & refrigeration, outdoor contractor applications, outdoor security, agriculture, mining and even the petrochemical industry.

Every Storm jacket & suit has been made to ensure thermal protection, water resistance, high-visibility if required and include valued features for practicality, safety & comfort.

Our premium Hydro-Plus rain suit has been designed to offer protection from chemicals and has flame resistant & anti-static properties.

Whether the temperatures are low or there's wind, driving rain and unpredictable conditions, being assuredly safe, dry and warm is something you can count on.

We believe you're entitled to maximum protection without compromise and we make sure you always get it.



Dromex

STORM



SFORM

APOLLO THERMAL JACKET

CODE: DB-APOLLO

- Bomber-style thermal protective & water-resistant jacket
- Outer: 280gsm Gabardine fabric
- Body lining: 240gsm 100% Polyester fleece fabric
- Sleeve lining: 100% Quilted Polyester 190T Taffeta & padding on sleeve: 180gsm 100% Polyester fabric
- 50mm Silver reflective tape on arms, waist & upper abdomen
- Elasticated rib knit cuffs & waistband
- Detachable sleeves with open end nylon zip
- Heavy-duty chunky nylon zip at front
- Two large side entry waist welt pockets
- Right breast pocket: a dual utility bellow pocket with flap Velcro closure and a chunky nylon closed end zip closure.
- Left breast bellow pocket: with storm flap Velcro closure and plastic ID card holder with Velcro closure.
- Internal right breast pocket with Velcro closure

Sizes: XS - 5XL

Suitable Use:

- Petrochemical
- Marine industry
- Agriculture
- Mining
- Outdoor & contractor applications
- Rain & wet conditions

NB

OR

SORM

WETPRO THERMAL JACKET

CODE: DB-WETPRO-LNB

- 2-Tone lime/navy blue reflective jacket
- Thermal protective & water-resistant storm jacket
- Composition:
 - Outer: 300D, 100% Oxford Polyester fabric
 - Lining: 100% Quilted Polyester 190T Taffeta fabric
 - Padding: 100% Polyester fabric
 - Storm cuff: 100% Polyester rib knit fabric
- Jacket includes a fixed stow away hood with drawstring fasteners & Velcro closure
- Heavy-duty chunky nylon zip, outer storm flap with large nylon press studs
- 2 Waist jet pockets with large straight cut flaps
- Utility/accessory bellow pocket with Velcro closure on right breast
- Internal left breast with patch pocket & nylon zip
- 50mm Silver reflective tape on arms, wrist, shoulders, waist & breast
- Inner jacket water drainage system

Sizes: XS - 5XL

Suitable Use:

- Petrochemical
- Marine industry
- Agriculture
- Mining
- Outdoor & contractor applications
- Rain & wet conditions





SORM

LITE WINDBREAKER

CODE: DB-STL

- Thermal protective hooded jacket
- Outer: 100% Polyester, 210T Fabric with PU coating
- Inner: 240gsm Polar fleece
- Sleeve: 160gsm Cotton with 190T Taffeta
- Fixed hood with drawstrings
- Heavy-duty nylon zip with metal puller
- Two side entry pockets with reflective trim
- Left breast pocket with press stud closure

Sizes: S - 3XL

Suitable Use:

- Cold/wet outdoor environments
- Cold storage & refrigeration

BLK

NB

SORM

HYDROPLUS RAIN SUIT

CODE: DB-HYDROPLUS

Designed to:



- 30% PVC, 60% Polyurethane & 10% Polyester, 310gsm fabric
- Premium rainsuit suitable for exposure to rain & wet conditions
- Fluorescent orange high visibility garment with 50mm silver reflective tape on arms, legs & torso and has flame resistant & anti-static properties
- Lightweight, water-resistant & comfortable
- Semi-opened rear and lined with polyester for breathability
- Heat sealed seams
- Jacket collar includes a fixed stow away hood compartment with drawstring fasteners
- Raglan sleeves with eyelets for aeration at armholes
- Heavy-duty chunky nylon zip, outer stom flap with large press studs and sleeves with storm cuffs
- 2 Large waist pockets with storm flaps
- Pants with elasticated waistband
- Ankle features press stud closures

Sizes: S - 3XL

Suitable Use:

- Petrochemical
- Marine industry
- Agriculture
- Mining
- Outdoor & contractor applications
- Rain & wet conditions





STORM

GLACIER FREEZER SUIT

CODE: DB-STG-J / P

- Navy blue, 2-piece freezer suit
- Splash proof & lightweight
- Outer: 100% Polyester 210T Oxford fabric with PVC coating
- Inner: 300gsm Cotton with 190T Polyester Taffeta
- Jacket includes a fixed hood with drawstrings, a heavy-duty zip & elasticated sleeve cuffs
- Trousers have an elasticated waist, two side pockets & open cuff legs

Sizes:

Jackets: S - 3XL

Pants: S - 3XL

Suitable Use:

- Cold storage & refrigeration
- Outdoor work in cold climate
- Contractor applications

SEORM

POLAR THERMAL REFLECTIVE SUIT

CODE: DB-STP-J / P

- 2-piece thermal suit with 50mm silver reflective tape on arms, waist & legs
- Thermal protective & water-resistant
- Outer: 100% Polyester 300D Oxford with PVC
- Inner: Polyester Taffeta with Cotton
- Jacket includes a detachable hood with drawstrings & a heavy-duty non-metal zip with storm flap & press stud closure
- Sleeves have an internal storm cuff
- Four utility jacket pockets with passants on shoulders with snap closure
- Pants have an elasticated waist with two side entry pockets
- Ankles have zip closure with apron seal
- Fully taped seams

Sizes:

Jackets: S - 4XL

Pants: S - 4XL

Suitable Use:

- Work in rain/wet /cold environments
- Mining
- Cold storage & refrigeration
- Outdoor work in cold climate
- Contractor applications
- Outdoor security





MAC RAINSUIT

CODE: DB-DMAC

- Navy blue, 2-piece freezer suit
- Splash proof & lightweight
- Outer: 100% Polyester 210T Oxford fabric with PVC coating
- Inner: 300gsm Cotton with 190T Polyester Taffeta
- Thermal flannel lining
- Jacket includes a fixed hood with drawstrings, a heavy-duty zip & elasticated sleeve cuffs
- Trousers have an elasticated waist, two side pockets & press stud closures on ankles

Sizes:

Jackets: S - 3XL

Pants: S - 3XL

Suitable Use:

- Cold storage & refrigeration
- Outdoor work in cold climate
- Contractor applications

NEW

AGRIMAC OIL SKIN BIB PANTS & JACKET

CODE: DB-AGRIMAC-BP / J

- Heavy-duty premium grade PVC
- 70% PVC outer lining, 30% Polyester inner lining
- Water-resistant jacket & bib pants suit
- Jacket with fixed hood, high collar & drawstring closures
- Sleeves with internal storm cuffs
- Hip pockets with hook & loop storm flaps
- Bib pants with high quality adjustable polyester webbing suspender and Polyoxymethylene buckle
- Jacket & bib pants sold separately

Sizes:

Jackets: S - 3XL

Pants: S - 3XL

Suitable Use:

- Work in rain / wet / cold environments
- General mining
- Agriculture
- Fishing
- Outdoor & contractor applications





HYDRO RAIN SUIT

CODE: DB-HYDRO

- **Recommended Product**
- Heavy duty PVC coated rain suit with hood
- 85% PVC 15% Polyester
- Jacket with fixed hood & drawstring closing
- Storm flaps over heavy-duty plastic zip with large plastic press stud closure
- Pants with elasticated waist and press stud closures on the ankles
- All seams are electro welded and stitched for durability
- Comfortable to wear

Sizes: S - 5XL



CODE: PRS70-Y

*For contractors / short term use

RUBBERISED RAIN COATS/SUITS



NB
BK
YL

CODE: PRSRUB



OR
FL

CODE: PRSRUB



YL
NB

CODE: RUBCOAT

STORM JACKET & BIP PANTS

CODES: JH-SM-G (JACKET)
BP-SM-G (BIB PANTS)

- Heavy duty PVC & Polyester inner lining, 481gsm
- Welded seams throughout for waterproof protection
- Jacket with fixed hood & drawstring, 2 pockets with storm flap, plastic double snap closure at the neck
- Sleeves with internal storm cuffs
- Bip pants have adjustable webbing suspender with plastic buckles

- Jackets & Bib pants sold separately

Sizes:

Jackets: S - 3XL

Bib Pants: S - 3XL

Suitable Use:

- General mining
- Marine & fishing industry
- Outdoor & contractor applications
- Rain & wet environments





CODE:
ARC 60X120



CODE: ACE 60X90
*2-piece



CODE:
ACE ONE 60X90



CODE:
ACE ONE 60X120

ARC & ACE APRONS

- Full or half length aprons with buckle closure, adjustable neck & waist strap
- Heavy-duty premium cow split leather
- Protects the worker's entire front of body

Suitable Use:

- Welding
- Maintenance
- Manufacturing
- Carpentry

TAEKI CUT5 CLOTHING



CODE: TAEKI JACKET
*excludes neck protector



CODE: TAEKI APRON 60120

LEATHER CLOTHING & KIDNEY BELT



CODE: DB-ACE YOKE



CODE: KBELT



CODE: DB-ACE SPAT



CODE: DB-SPAT KNEE

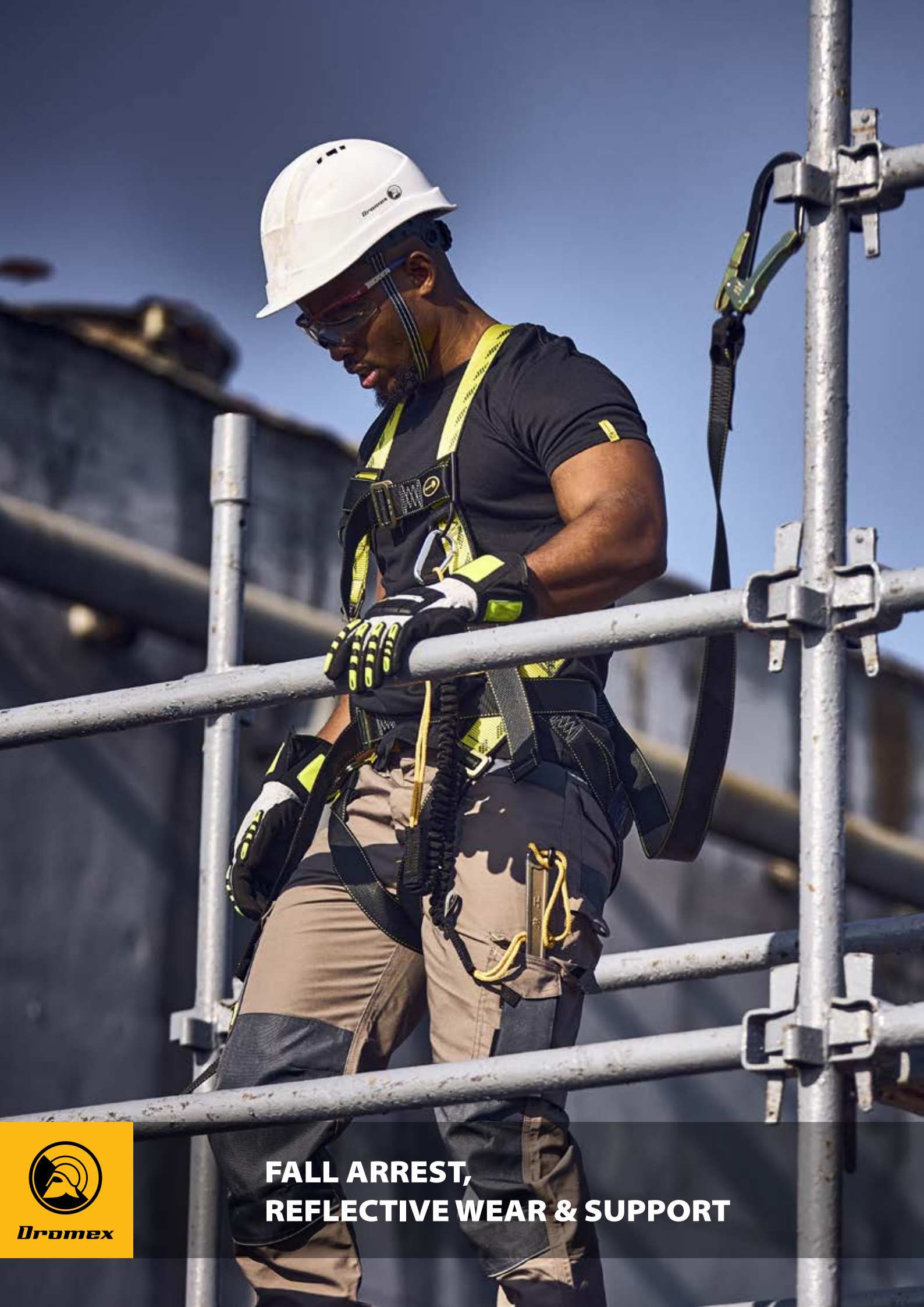

**FALL ARREST,
REFLECTIVE WEAR & SUPPORT**



Dromex

FALL ARREST



CODE: DFA-PN10-PS



CODE: DFA-PN10

FULL BODY HARNESSSES



- Polyester full body harness with adjustable chest & leg straps
- Includes a Dorsal D-Ring for fall arrest
- Ideally placed sit strap for extended comfort
- Equipped with Lanyard Keepers for placement of free lanyards
- Weight capacity of 140kg (incl. tools)

DFA-PN10

- Includes shock absorbing double lanyard with steel scaffold hooks (DFA-PN361N) and 25mm chest strap

DFA-PN21

- Includes shock absorbing double lanyard with steel scaffold hooks (DFA-PN361N)
- Adjustable 44mm sliding chest strap, shoulder straps, leg straps and waist belt

Sizes: One Size

- Meets the requirements of the European PPE Regulation (EU) 2016/425
- Certified to EN 361:2002 and EN 355:2002

Suitable Use:

- Construction industry
- Cleaning, painting & building maintenance
- Scaffolding applications
- Refineries
- Oil Rigs



CODE: DFA-PN21



DOUBLE SCAFF HOOK LANYARD

CODE: DFA-PN361N



- Fall Arrest 44mm Forked Webbing Lanyard made from high tenacity polyester (1.75m length)
- Consists of Energy Absorber with loop and Steel Scaffold Hooks
- Allows movement in all directions while remaining safely anchored at all times
- Loops are protected by an abrasion resistant covering at the ends and prevents the webbing from being damaged by the metallic connector.
- Certified as per EN 355:2002

ACCESSORIES



TOOL LANYARD
CODE: DFA-TL01



TWIN TOOL LANYARD
CODE: DFA-TL02



SUSPENSION INTOLERANCE STRAP
CODE: DFA-ST501



RETRACTABLE FALL ARRESTER (15M)
CODE: DFA-TPGS15



RETRACTABLE FALL ARRESTER (6M)
CODE: DFA-TPGS06



RETRACTABLE WEBBING MINI BLOCK (2.5M) WITH SWIVEL
CODE: DFA-PN2002



RETRACTABLE FALL ARRESTER (2M) WITH HOOK
CODE: DFA-MIC02

RETRACTABLE FALL ARRESTERS



- Vertical length systems (DFA-PN2002)
- Vertical & horizontal length systems (DFA-TPGS15 and DFA-TPGS06)
- Colour impact indicators at attachment ends
- Certified as per EN 360:2002



REFLECTIVE WEAR: GENERAL INFORMATION

To ensure that your reflective garment is effective it needs to conform to EN ISO 20471:2013.

What is EN ISO 20471?

EN ISO 20471 is a revised version of the previous EN 471 high visibility PPE standard. According to Directive 89/686/EEC, it requires by law to protect people who work on or near a roadside, whilst they go about their day to day business.

The standards are set by identifying the risks to people. This is the minimum standard for high visibility clothing, which is capable of visually signalling the user's presence and which specifies test methods and performance requirements for PPE worn in high-risk situations.

What is the main criteria for the standard?

Colour and retroreflection as well as for the minimum areas and for the placement of the materials in protective clothing. Three classes of garment are defined based on three different minimum areas of retroreflective, fluorescent and/or combined performance materials. Each of these classes will provide a different level of conspicuity.

Material	Class 3 Garments	Class 2 Garments	Class 1 Garments
Background material	0,80	0,50	0,14
Retroreflective material	0,20	0,13	0,10
Combined performance material	n.a.	n.a.	n.a.

NOTE: The clothing class is determined by the lowest area of visible material.

Class 3 is the class that provides the highest degree of conspicuity against most backgrounds found in urban and rural situations in daylight and in night time. There are within the standard, certain requirements for in-use test requirements.

The standard takes into consideration the materials require brightness after:

- | | |
|---------------------------------|-------------------------|
| Retroreflective | Flourescent |
| Rainfall performance | UV exposure |
| Temperature variation | Dimensional change |
| Abrasion | Water vapour resistance |
| Cold folding | Colour fastness |
| Flexing | Mechanical properties |
| Washing | |
| Dry cleaning (where applicable) | |



CODE: SA14-NS



CODE: SA13-SL

2-TONE REFLECTIVE JACKETS 100% POLYESTER TRICOT/MESH FABRIC

CODE: SA13-SL

SA14-NS (SLEEVELESS)

- Polyester & mesh fluorescent lime open weave fabric
- Reflective tape is 50mm silver bead industrial washing T/C tape
- Nylon zip fastener with metal slider & buttons
- Identity card holder on left breast (SA13-SL only)
- Garment Class 2
- Enhanced visibility from all sides
- Detachable zip sleeves (SA13-SL)

Sizes: S - 3XL & 5XL

- Manufactured to ISO 20471:2013 (EN 471 & SANS 50471) as per requirements of 89/686/EEC.

Suitable Use:

- Construction industry
- Warehouse environment
- Mining industry
- Police/law enforcement



FLAME RETARDANT REFLECTIVE VEST

CODE: SA003-FR

- Flame retardant vest made with 100% Polyester fluorescent lime open weave fabric
- Flame retardant tape is 100% Cotton woven fabric with micro-glass bead coating, 520g/m²
- Velcro closure
- Black Polyester binding
- Garment Class 2

Sizes: S - 5XL

Suitable Use:

- Construction industry
- Warehouse environment
- Mining industry

Compliance

Tape: EN ISO 20471:2013 & EN 469:2005+A1+AC
Fabric: ISO 6330:2012, EN ISO 14116:2008



FLAME RETARDANT & ANTI-STATIC REFLECTIVE VEST

CODE: SA11-ASFR

- Flame retardant & anti-static vest made with 96% Polyester fluorescent lime open weave fabric & 2% carbon thread
- Flame retardant tape is 100% Cotton woven fabric with micro-glass bead coating, 520g/m²
- Nylon zip fastener with metal slider
- Clear on black top entry plastic pouch
- Black Polyester binding
- Garment Class 2

Sizes: S - 3XL

Suitable Use:

- Construction industry
- Warehouse environment
- Mining industry

Compliance

Tape: EN ISO 20471:2013 & EN 469:2005+A1+AC
Fabric: ISO 6330:2012, EN ISO 14116:2008



2-TONE MESH REFLECTIVE VEST

CODE: SA50Y-OR / YB

- 100% Polyester fluorescent yellow/navy or yellow/red knitted weave fabric
- 18mm Reflective tape - retro-reflective silver glass beads
- Nylon zip with metal slider
- Clear PVC on black top entry plastic pouch/ID pocket

Sizes: S - 3XL

Suitable Use:

- Construction industry
- Warehouse environment
- Mining industry



MESH REFLECTIVE VEST

CODE: SA7B2

****MESH VENTILATION WITH PVC TAPE**

- Nylon lime zip with metal slider.
- Clear PVC on black top entry ID pouch
- Space for branding on back of vest

Sizes: S - 5XL

2-TONE REFLECTIVE VEST

CODE: SA-2T

- Nylon black zip with metal slider
- Clear PVC on black top entry ID pouch
- White reflective tape

Sizes: S - 5XL

SA10 REFLECTIVE VEST

CODE: SA10-LIME

- Nylon zip with metal slider.
- Clear PVC on black top entry ID pouch
- Construction/warehouse/mining

Sizes: S - 5XL



GLASS FIBRE FIRE BLANKET

CODE: FBGF

Complies with requirements of EN 1869 :1997

- 100% Glass fibre
- Heat resistant, light duty fire blanket designed to extinguish small incident fires
- Protects human lives & equipment from fire
- Withstands temperatures reaching 550°C
- Supplied in a red, clearly marked bag that can be hung on nearby walls for quick access

Sizes: 2m x 2m

Suitable Use:

- Household kitchen fires (oven & stove)
- Extinction of fire on clothing
- Catering establishments/restaurants
- Training centres
- Hospitals & nursing facilities
- Laboratories
- Garage & workshops
- Retail outlets
- Flammable liquid cans
- Cinema projection rooms
- Office buildings



CERAMIC FIRE BLANKET

CODE: FBCER

- 1200°C Ceramic fibre cloth
- Low thermal conductivity
- High temperature stability
- Excellent tensile strength

Size: 2m x 2m

Suitable Use:

- Construction industry
- Warehouse environment
- Mining industry





WELDING SCREENS

CODE: WELDSR

- 100% Flame Retardant PVC
- Brass eyelets

Sizes:

- 2m x 2m
- 2m x 3m

Suitable Use:

- Construction industry
- Warehouse environment
- Mining industry



CODE: FA-3



CODE: FA-3/REFILL

FIRST AID KITS

FIRST AID KIT FA-3 & FA-7

- Emergency treatment for sick or injured
- White, portable & wall mountable steel box

Replacement Contents Available:

- FA-3/Refill
- FA-7/Refill

Suitable Use:

- Indoors
- Offices
- Manufacturing environment



CODE: FA-7



CODE: FA-7/REFILL

INFRARED THERMOMETER

CODE: DH-IF-THERMO

- LED luminous display function
- High sensor quality
- Automatic high temperature warning alarm
- One key operation
- Has a large memory capacity

Suitable Use:

- Hospitals
- Airports
- Schools
- Mobile screenings
- Home





FOOT PROTECTION



Dromex



DISCLAIMER

It is recommended that the local standards and regulations for foot protection, recommendations for selection, use, care and maintenance should be used. This information is a guide for selection only. All footwear is manufactured to statutory and specific tender requirements and should not be modified in any way.

ISO 20345:2011

The standard covers all requirements for safety footwear - the understanding of the classifications, categories and other performance requirements will allow the user to select the correct shoe or boot for the intended operation and potential hazards.

CLASSIFICATION OF FOOTWEAR

I	Footwear made from leather and other materials
II	All-rubber entirely vulcanised or all-polymeric entirely moulded

MARKING CATEGORY

Category	Class	Performance
SB	I	Impact & Compression
S1	I	SB + Closed Seat + A + E
S1P	I	S1 + P
S2	I	S1 + WRU
S3	I	S2 + P + Cleated Outsole
S4	II	SB + A + E
S5	II	S4 + P + Cleated Outsole

TEST REQUIREMENTS

SYMBOL	REQUIREMENTS	PERFORMANCE
SB	Impact resistance (Steel toe cap)	>200 J (Joule)
	Compression test	>15kN
P	Puncture resistant sole	≥1,100N
C	Electrical resistant	<100 kQ
A	Anti-static	100 kQ ≤1 000 MQ
I	Electrically insulating footwear	Class 0 or 00
HI	Insulates against heat	Up to 150°C
CI	Insulates against cold	Up to -20°C
E	Energy absorption in heel	≥20J
WR	Water resistant footwear	≤3 cm ²
M	Metatarsal protection	> 200J
AN	Ankle protection	>30kN
WRU	Uppers resistant to water penetration	≥60 mins
CR	Cut resistant upper	≥2.5 (Index)
HRO	Heat resistant outsole	Up to 300°C

MARKING FOR SLIP RESISTANCE

SRA	Slip resistance on ceramic tile floor with SLS*
SRB	Slip resistance on steel floor with glycerol
SRC	Slip resistance on ceramic tile floor with SLS* and on steel floor with glycerol

*SLS = Sodium lauryl sulphate solution



ULTECO^{PLUS} BOOT

CODE: DF-SK7026

NRCS/9002/217251/0005



- Conforms to EN ISO 20345:2011, NRCS/9002/217251/0005 as per SANS 20345:2014
- Water resistant Buffalo Buff leather upper
- Steel midsole protects against penetrating surfaces and objects
- Cleated oil & slip resistant outsole, SRC (Slip resistance on ceramic tile floor with NaLS (sodium lauryl sulphate) and on steel floor with glycerine^{^c})
- Dual density PU (Polyurethane) lightweight outsole and an insole with anti-static technology
- Heat insulation properties on the outsole up to 95° C
- Outsole with energy absorption heel.
- Removable and breathable PU and Memory Foam insole for superior comfort
- Impact resistant steel toecap rated up to 200 ± 4 Joules
- Scuff cap for extra toe reinforcement & upper protection

- Wider toecap for extra room and comfort
- Bellows tongue prevents liquids and particulates from entering the boot

Sizes: 3 - 13

Suitable Use:

- General use
- Warehouses
- Freight industry
- Mining
- Engineering
- Construction

ULTECO

CODE: DF-UBLK

NRCS/9002/217251/0321



- Conforms to EN ISO 20345:2011, NRCS/9002/217251/0321 as per SANS 20345:2014
- Full grain Buffalo leather upper
- Oil & slip resistant outsole, SRC (Slip resistance on ceramic tile floor with NaLS & on steel floor with glycerine^{^c})
- Heat insulation properties of the outsole withstands up to 95°C
- Energy absorbing heel
- Removable and breathable PU and Memory Foam insole for superior comfort
- Bellows tongue & padded collar for added comfort
- Anti-static removable in-sock
- Steel toe cap is impact resistant up to 200 ± 4J
- Wider toecap provides extra room & comfort
- Cleated outsole for additional traction
- Scuff toe over-cap for extra reinforcement
- BASF PU dual density outsole

Sizes: 3 - 13

Suitable Use:

- General use
- Warehouse environment
- Freight industry
- Mining
- Engineering
- Construction



CODE: SS1020/SHOE
NRCS/9002/271251/0006



CODE: SS1020/BOOT
NRCS/9002/271251/0004

S1 BOXER SHOE & BOOT



- Conforms to EN ISO 20345:2011
- Water resistant, split grain leather upper
- Slip resistant sole, SRC (Slip resistance on ceramic tile floor with NaLS (sodium lauryl sulphate) and on steel floor with glycerine^Λc)
- Durable & lightweight dual density PU outsole
- Cleated outsole provides additional traction on slippery surfaces
- Impact resistant steel toecap rated up to 200 ± 4 Joules
- Anti-static, reducing the hance of electrostatic discharges
- Energy absorbing heel

- Removable EVA insock
- Injected dual density polyurethane outsole

Sizes: 3 - 13

Suitable Use:

- Ideal as a boot or shoe for contract workers
- General use
- Warehouse environment
- Freight industry

ULTECO SHOE

CODE: DF-USHOE

NRCS/9002/217251/0006



- Conforms to EN ISO 20345:2011, NRCS/9002/217251/0006 as per SANS 20345:2014
- Durable Buffalo Buff leather upper
- Cleated oil & slip resistant outsole, SRC (Slip resistance on ceramic tile floor with NaLS (sodium lauryl sulphate) and on steel floor with glycerine^{^c})
- Dual density PU (Polyurethane) lightweight outsole and an insole with anti-static technology
- Heat insulation properties on the outsole up to 95° C
- Outsole with energy absorption heel
- Removable and breathable PU and Memory Foam insole for superior comfort
- Impact resistant steel toecap rated up to 200 ± 4 Joules
- Wider toecap for extra room and comfort
- Bellows tongue prevents liquids and particulates from entering the boot
- Scuff cap for extra toe reinforcement & upper protection

Sizes: 3 - 13

Suitable Use:

- General use
- Warehouse environment
- Freight industry
- Mining
- Engineering
- Construction



NOBUHLE LADIES BOOT

CODE: DF-NOBUHLE

NRCS/9002/217251/0238



- Conforms to EN ISO 20345:2011, NRCS/9002/217251/0238 as per SANS 20345:2014
- Durable Buffalo Buff leather upper
- Cleated oil & slip resistant outsole, SRC (Slip resistance on ceramic tile floor with NaLS (sodium lauryl sulphate) and on steel floor with glycerine^{^c})
- Dual density PU (Polyurethane) lightweight outsole and an insole with anti-static technology
- Heat insulation properties on the outsole up to 95° C
- Outsole with energy absorption heel
- Removable and breathable PU and Memory Foam insole for superior comfort
- Impact resistant composite toecap rated up to 200 ± 4 Joules

- Metal free lace fastenings
- Wider toecap for extra room and comfort

Sizes: 2 - 9

Suitable Use:

- General use
- Warehouse environment
- Freight industry
- Mining
- Engineering
- Construction



CHELSEA BOOTS

CODE: DF-CHELSEA

NRCS/9002/217251/0438



- Conforms to EN ISO 20345:2011, NRCS/9002/217251/0438 as per SANS 20345:2014
- Made from premium full grain Crazy Horse leather
- Steel midsole protects against penetrating surfaces and objects
- Cleated oil and slip resistant outsole, SRC (Slip resistance on ceramic tile floor with NaLS (sodium lauryl sulphate) and on steel floor with glycerine[^]c)
- Dual density PU (Polyurethane) lightweight outsole and an insole with anti-static technology
- Heat insulation properties on the outsole up to 95° C
- Outsole with energy absorption heel
- Removable and breathable PU and Memory Foam insole for superior comfort

- Impact resistant steel toecap rated up to 200 ± 4 Joules
- Wider toecap for extra room and comfort

Sizes: 3 - 13

Suitable Use:

- General use
- Warehouses
- Freight industry
- Mining
- Engineering
- Construction

COMING SOON



SWIFT SAFETY SNEAKER SHOE

CODE: DF-SWIFT



- Conforms to EN ISO 20345:2022
- Anti-rip material upper for durability & breathability
- Metal-free construction
- Impact resistant fibreglass toecap rated up to 200 ± 4 Joules
- Cleated oil & slip resistant outsole, SR (Slip resistance on ceramic tile floor with glycerine^{^c})
- Lightweight Kevlar midsole for protection from penetrating objects
- Single density PU (Polyurethane) lightweight outsole and an insole with anti-static technology

Sizes: 3 - 13

Suitable Use:

- General use
- Warehouses
- Freight industry
- Engineering
- Construction



DF-FLITE



DF-FLITE-L

FIBRE LITE SAFETY SNEAKERS

CODE: DF-FLITE (MEN'S) / DF-FLITE-L (LADIES)



- Conforms to EN ISO 20345:2022
- S1P safety sneaker (energy absorption seat region, resistance to fuel and oil)
- Breathable & durable oxford mesh upper with TPR accents
- A SR oil & slip resistant outsole (Slip resistance on a ceramic tile floor with glycerine[^]c)
- Impact resistant fibreglass toecap rated up to 200 ± 4 Joules
- Lightweight Kevlar midsole for protection from penetrating objects
- Cleated EVA lightweight rubber outsole with grips for traction on terrain
- Reinforced nuback heel & TPU (Thermoplastic Polyurethane) toe bumper for added protection
- Anti-static insole reduces the chance of electrostatic discharge
- Heat insulation properties on the outsole up to 120° C
- Outsole with energy absorption heel
- Removable EVA insock for comfort & easy cleaning

- Metal Free
- Available in Men's & Ladies' options

Sizes:

Men's: 3 - 13

Ladies: 2 - 9

Suitable Use:

- General use
- Warehouses
- Freight industry
- Mining
- Engineering
- Construction

NEW



EMPEROR SMELTER BOOT

CODE: DF-EMPEROR



- High performance, metal free, superior flame retardant and electrical resistant safety boot with a metatarsal guard
- Conforms to EN ISO 20349-1:2017+A1:2020
- Protection against electrical hazard risks of 18kV in accordance with ASTM F2413-18
- Made from premium full grain European cow leather, which is flexible, waterproof, chromium VI free and durable
- Lightweight Kevlar midsole for protection from penetrating objects & heat
- A PU/nitrile rubber outsole that is lightweight, durable and aids boot temperature control
- Cleated & oil and slip resistant outsole, SRC (Slip resistance on ceramic tile floor with NaLS (sodium lauryl sulphate) and on steel floor with glycerine^{^c})
- External foot bridge metatarsal guard rated up to 100 Joules
- Contact heat resistant outsole at 300° C for 60 seconds
- Outsole with energy absorption heel
- Removable and breathable PU and Memory Foam insole for superior comfort
- Impact resistant fibreglass toecap rated up to 200 ± 4 Joules
- Wider toecap for extra room and comfort
- Slip-on design with multiple hook & loop straps for quick release

Sizes: 5 - 13

Suitable Use:

- Foundry
- Smelting
- Welding

SPARTICUS GUMBOOT

CODE: DF-SP-STCM



- PVC (Polyvinyl Chloride)/Nitrile composition
- Slip resistant outsole, SRC (Slip resistance on ceramic tile floor with NaLS and on steel floor with glycerine^c)
- A penetration resistant stainless-steel midsole
- An impact resistant steel toe cap that withstands up to 200 ± 4 J, and a compression resistance of 15KN.
- Basic light chemical spray and splash protection and tested to acetic acid at a concentration of 99± 1% as per EN 13832-3:2006
- Reinforced shin, ankle, heel and toe protection
- Energy absorbing heel.
- Anti-static, reducing the chance of electrostatic discharges
- Cleated outsole for additional traction on slippery surfaces
- A broad fitting toe region allowing a comfortable fit for men and ladies feet, especially over long periods of time.

Sizes: 4 - 13

Suitable Use:

- Warehouse environments
- Agriculture
- Freight industry
- Contractors

ARMOUR GUMBOOTS

CODE: DF-ARMOUR



- PVC (Polyvinyl Chloride)/Nitrile composition
- Slip resistant outsole, SRC (Slip resistance on ceramic tile floor with NaLS and on steel floor with glycerine^c)
- Reinforced shin & ankle protection
- Energy absorbing heel
- Anti-static, reducing the chance of electrostatic discharges
- Oil resistant & cleated outsole
- Average weight: 1.9kgs

Sizes: 4 - 14

Suitable Use:

- Food Processing
- Fisheries
- Agriculture
- Janitorial



MIGHTY NITE GUMBOOT

CODE: DF-GB-MN

- Knee-length PVC / Nitrile gumboots
- Anti-bacterial, hygienic & lightweight
- Slip resistant outsole, SR (Slip resistance on ceramic tile floor with NaLS and on steel floor with glycerine^{^c})
- Energy absorbing heel
- Anti-static, reducing the chance of electrostatic discharges
- An oil resistant and cleated outsole providing additional traction on slippery surfaces
- A wide toe region for hours of comfort
- Reinforced shin and ankle protection
- Easy to pull off tab construction
- Average weight: 1.7 - 1.9kg's (size dependant)

Sizes: 4 - 13

Suitable Use:

- Food processing
- Butcheries
- Fisheries
- Agriculture



LADIES LITE GUMBOOT

CODE: DF-GB-LL

- Calf-length PVC / Nitrile gumboots
- Anti-bacterial, hygienic & lightweight
- Slip resistant outsole, SR (Slip resistance on ceramic tile floor with NaLS and on steel floor with glycerine^{^c})
- Energy absorbing heel
- Anti-static, reducing the chance of electrostatic discharges
- An oil resistant and cleated outsole providing additional traction on slippery surfaces
- A wide toe region for hours of comfort
- Reinforced shin and ankle protection
- Easy to pull off tab construction
- Average weight: 1.0 - 1.2kg's (size dependant)

Sizes: 3 - 9

Suitable Use:

- Food processing
- Butcheries
- Fisheries
- Agriculture





FLAME RETARDANT SOCKS

CODE: DF-9162-CH-L



- Ribbed cuff for secure fit
- Reinforced heel & toe for durability
- Blister resistant
- Thermally balanced & odour free
- Will not burn when exposed to heat & flame
80% Wool, 15% Nylon, 4% Lycra, 1% Elastane
Aflammit® ZR treated yarn

Sizes: Large (8 - 11)

Suitable Use:

- Petroleum service industry
- Petrochemical industry
- Oil & gas industry
- Electrical & gas utility
- Steel mills
- Fighter pilots



BLACK

ANTI-STATIC SOCKS

CODE: DF-9161

- 64% Cotton, 9% Polyester, 4% Silver Yarn, 21% Elastane, 2% Polyamide
- Designed to safely conduct static build-up away from workers & equipment
- Anti-bacterial fibres
- Ribbed cuff for secure fit
- Elasticated arch & padded sole for extra comfort

Sizes:

- Medium (4 - 7)
- Large (8 - 11)

Suitable Use:

- Manufacturing (incl. computer equipment)
- Refineries



NAVY BLUE



NAVY BLUE



BLACK



CHARCOAL



KHAKI

WORKWEAR SOCKS

CODE: DF-9160

- 62% Cotton, 27% Elastane, 9% Polyester
2% Polyamide
- Reinforced heel & toe for durability
- Ribbed cuff for secure fit
- Cushioned feet & sole for comfort
- Cotton & Polyester blend enhances
comfort & breathability
- Perfect for all-day use

Sizes:

- Medium (4-7)
- Large (8 - 11)

Suitable Use:

- Warehousing
- Janitorial
- Gardening
- General use

We believe that all employees in any work environment are entitled to maximum safety protection and that employers should not have to compromise on the quality of the PPE products they provide for their staff.

KZN HEAD OFFICE
Cornubia Ridge Logistics Park
30 Umganu Road,
Flanders, Blackburn, 4319
South Africa

E. sales@dromex.co.za
T. +27 (0)31 713 1960

JOHANNESBURG
7 Mirage Road,
Bedfordview,
Germiston, 2008
South Africa

T. +27 (0)11 450 0444

CAPE TOWN
Unit A26, Block 1
Northgate Office Park
Section Road, Brooklyn
Cape Town, 7405
South Africa

T. +27 (0)21 224 0935

PORT ELIZABETH
Unit F7-F10
Circular Business Park
31 Circular Drive
Port Elizabeth, 6070
South Africa

T. +27 (0)41 250 0040



Dromex

www.dromex.co.za

APRIL 2024